

**m**Gard Trapped Key Technology

**am**Gard Safety Gate Switch Interlocks

**e**Gard Total Access & Control

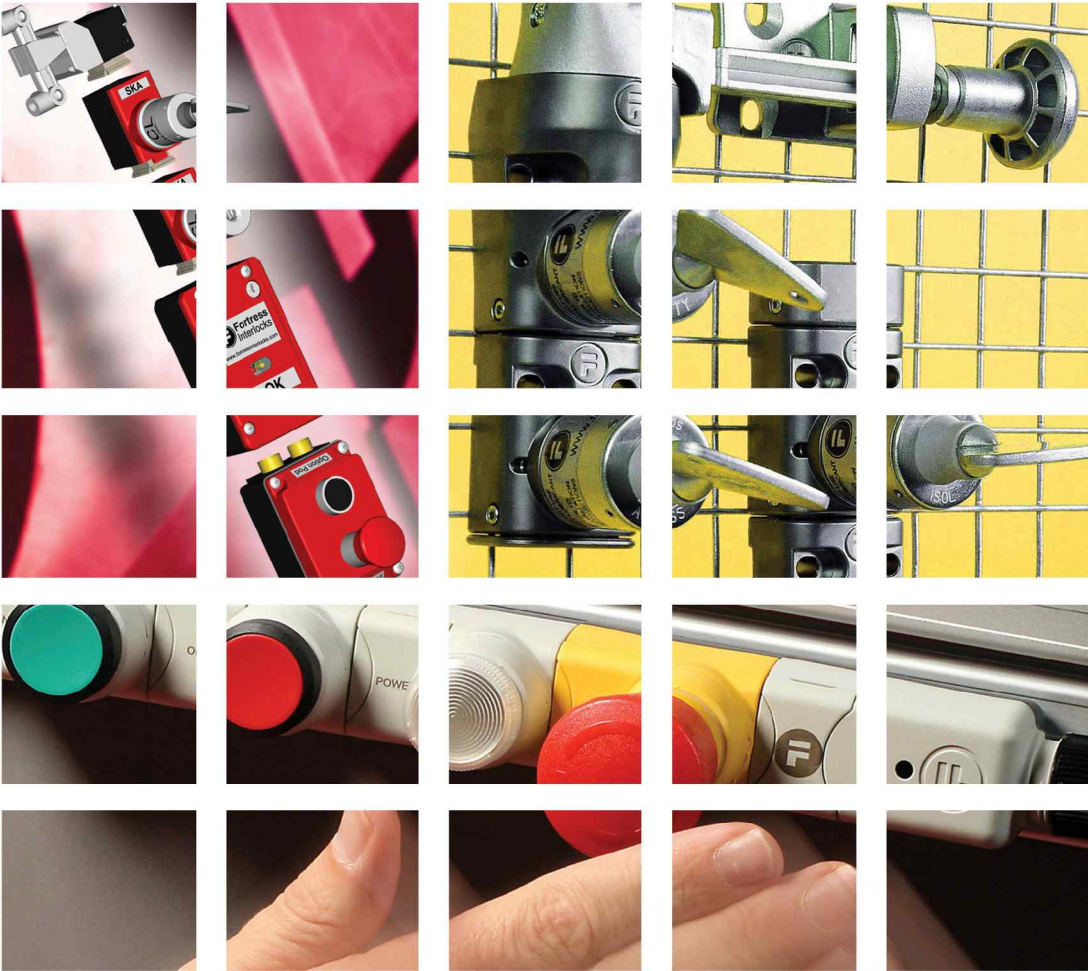

# Product Catalogue

Total Access & Control

## “Who we are”

A market leader, Fortress Interlocks design and manufacture safety access & control systems. Fortress offer an unrivalled portfolio suitable for applications across a wide industrial base from power generation and distribution, steel, automotive, recycling, building materials, through safeguarding robots and palletisers.

With in excess of 40 years experience in the safety market, Fortress are renown for their innovative design, robust engineering and reliability.

## “What we do”

Fortress help customers protect their human and capital assets. We create safe workplaces where employees are safeguarded from injury and plant is protected from damage.

We are world leaders in access control systems, and our products guarantee that actions and events are undertaken in a pre-determined sequence ensuring a safe working environment.

## “Total Access & Control”

With the introduction of **eGard**, Fortress can provide “Total Access & Control”, from cost effective general duty access interlocks and simple automation control systems (**eGard**), to the most robust trapped key interlocks (**mGard**) or safety gate switches (**amGard**).

## “Why choose Fortress”

Fortress are a solution provider and our extensive product offering and interlocking experience allows us to provide unique solutions for all safeguarding applications. We regularly create bespoke solutions, often by customising our standard products.

# Fortress Interlocks

## The Global Supplier of Total Access and Control Safety Systems.



NB Our brochure is designed to give an overview of our brand portfolio. For detailed technical information including 2D autocad file downloads, 3D animated product views and specific application information, visit our web site [www.fortressinterlocks.com](http://www.fortressinterlocks.com).



**Key Interlock Systems**



|  |    |
|--|----|
| What is mGard                          | 4  |
| Application Examples                   | 5  |
| Modular Components                     |    |
| Power/Control Isolation                | 7  |
| Key Exchange Units                     | 10 |
| Door Locks & Actuators                 | 11 |
| Accessories & Technical Specifications | 12 |
| Range Card                             | 13 |

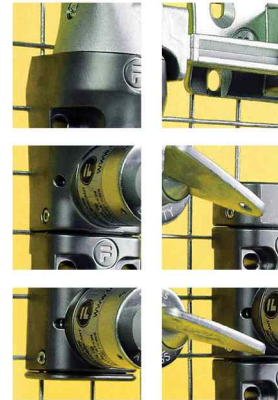

**Safety Gate Switch Interlocks**



|                              |    |
|------------------------------|----|
| What is amGard               | 14 |
| Application Examples         | 15 |
| Modular Components           |    |
| Head Modules                 | 16 |
| Adaptor Modules              | 17 |
| Electrical Switching/Locking | 19 |
| Option PODs                  | 20 |
| Technical Specifications     | 21 |
| Range Card                   | 23 |

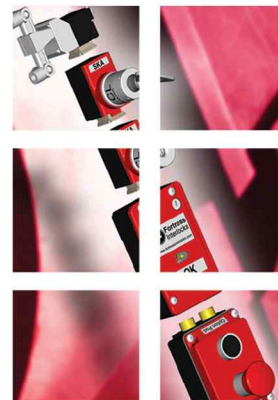

**Access & Control Systems**



|                          |    |
|--------------------------|----|
| What is eGard            | 24 |
| Application Examples     | 25 |
| Modular Components       |    |
| Head Modules & Actuators | 26 |
| Core Modules             | 27 |
| Base Modules             | 30 |
| Cables & Accessories     | 31 |
| Technical Specifications | 32 |
| Range Card               | 34 |





**mGard** is the premier range of modular robust trapped key interlocks for heavy duty applications. Trapped key interlocking is a tried and tested method of mechanically safeguarding dangerous machines and hazardous processes, and is suitable for use up to SIL3 (EN/IEC 62061) Category 4 and PLe (EN/ISO 13849-1).

It is called "Trapped Key" as it works by releasing and trapping keys in a predetermined sequence. After the control or power has been isolated, a key is released that can be used to grant access to individual or multiple doors.

The principles of trapped key technology apply to all industries where it is essential that all energy sources are isolated before gaining access to machinery. Almost all safety issues can simply be solved by selecting the required products in order of the steps shown on this page.



SE-CLIN-A02022

Power/Control Isolation

**Identify the energy sources to be isolated and/or any hazard that cannot immediately be isolated such as; heat, pressure, radiation or machine rundown time**

- |  |  |
|--|--|
| <p><b>Power isolation</b></p> <ul style="list-style-type: none"> <li>• Mechanical Bolt Interlock</li> <li>• Bolt Interlock with Limit Switch</li> <li>• Bolt Interlock with Switch</li> <li>• Breaker Locks</li> </ul> | <p><b>Control isolation</b></p> <ul style="list-style-type: none"> <li>• Key Switches</li> <li>• Solenoid Controlled Key Switch</li> <li>• ATEX Key Switch</li> <li>• ATEX Solenoid Controlled Key Switch</li> <li>• Solenoid Controlled Key Switch Unit</li> <li>• Electronic Time Delay Unit</li> <li>• Voltage Sensing Unit</li> <li>• Knob and Key Operated Switch Control Unit</li> </ul> |
|--|--|



XM4-MLIN

Key Exchange

**Identify the type and number of access points.**

- Key Exchange Units
- Key Exchange Units with Switch

Because of the modular arrangement of **mGard** both key exchange and door lock units can easily be extended with an *extension module (XMA)*, for instance when doors are added to the safeguarded area or machine.

The Fortress Trapped Key System allows the safeguarding of potentially hazardous areas without the need for wiring.

All Fortress Interlocks rotary switches have European, Canadian, Chinese and North American approvals.



DM2-MLIS-S

Door Locks & Actuators

**Identify the type of access point; part body or full body access doors with or without the use of personal safety keys (to prevent accidental lock in).**

- Single Door Interlocks
- Multiple Door Interlocks
- Fixed actuator
- Handle operated actuator
- Spring loaded handle operated actuator
- Self aligning actuator
- Compressible actuator

For dimensional drawings please use the Datasheets/Installation Manuals at [www.fortressinterlocks.com](http://www.fortressinterlocks.com)



**mGard Application Example I (safeguarding without rundown time)**

By using a trapped key system, this mixer is safeguarded in a pre-determined sequence without the need for wiring. mGard products are very robust and ideal for use in harsh conditions, such as heat, vibration, dust and moisture.

**1 BM1-CLIN**

First the isolation switch is operated into a safe condition. Only in this "off" position it is possible to shoot the bolt of the BM1 bolt-lock to isolate the switch and release the key.

**2 XM3-CLIN**

The isolation key can now be inserted into the XM3 key exchange box and trapped, allowing the two access keys to be released.

**3 DM1-CLIS-H**

The two access keys can be inserted into the handle operated door interlocks located on the mixer, enabling the hatches to be opened for maintenance or repair purposes.

Mixer restart is only possible after reversing the sequence.

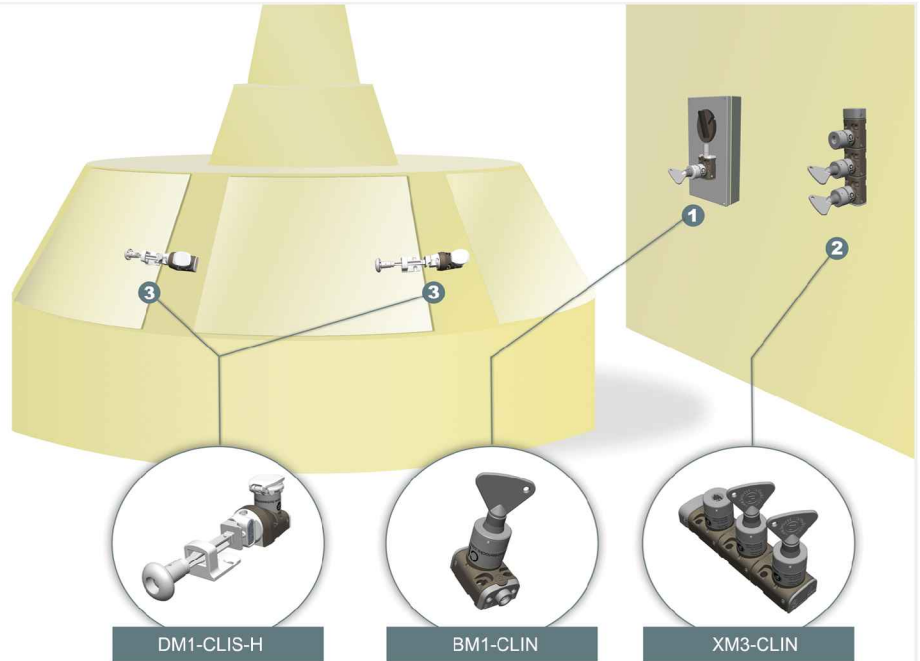

**mGard Application Example II (safeguarding with rundown time)**

This enclosed machine area is safeguarded with the use of a solenoid controlled trapped key interlock system. The modular arrangement allows configurations of virtually any safeguarding application.

**1 SS1-CLIN-A02022D024B**

After remote request for access and/or rundown time, the solenoid of the SS1 solenoid controlled key switch is energised, releasing the key. After releasing the isolation key, the machine is isolated.

**2 XM3-CLIN**

The isolation key can be inserted into the XM3 key exchange box to release two access keys.

**3 DM1-CLIN-H & DM2-CLIN-H**

The access keys can be used to open the doors to the safeguarded area. Full body access doors are equipped with a safety key, that can be taken into the safeguarded area, to prevent accidental lock in.

Machine restart is only possible after reversing the sequence.

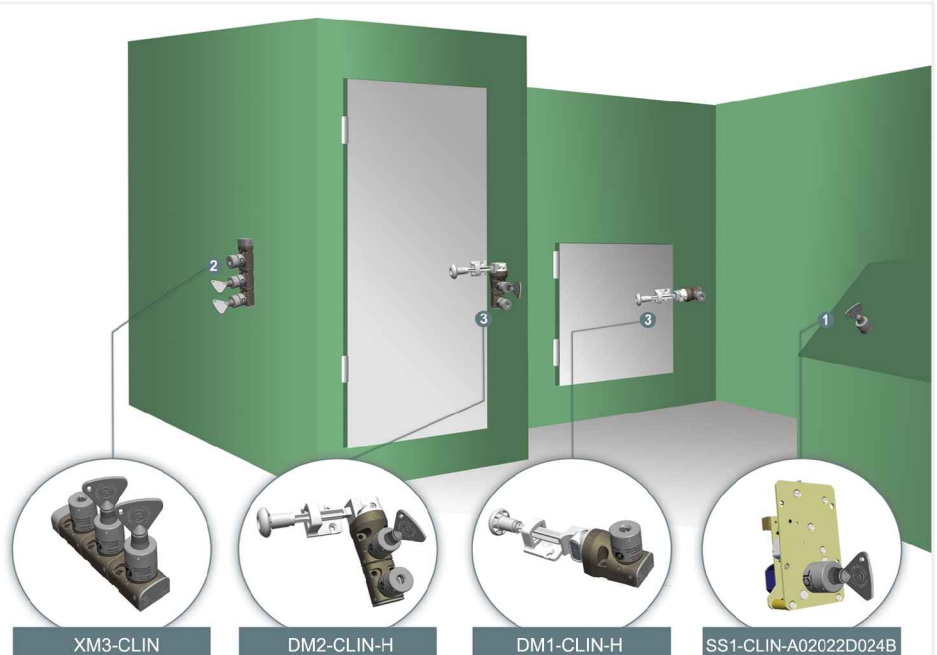

**mGard Application Example III (mGard linked to amGard)**

By combining the **mGard** range of trapped key interlocks, with the electro mechanical functions of the **amGard** range, additional safety features can easily be integrated to take advantage of the benefits of control isolation/interlocking.

In this example an mGard solenoid controlled key switch unit is used to safely control the use of amGard switch controlled door locks.

**1 SS2-CLIN-A02022D024B**

After remote request for access and/or rundown time, the solenoid of the SS2 solenoid controlled key switch is energised releasing the two keys "A". After releasing at least one of these isolation keys, the machine is isolated.

**2 AMS1A1STOP024CLIN**

The two keys "A" can be inserted into the handle operated door locks, to access the safeguarded area.

This configuration is equipped with two additional safety functions: A Safety switch which monitors the presence of key "A" and a safety key adaptor with safety key "B" to prevent accidental lock in and/or machine restart.

SS2-CLIS-A02022D024B

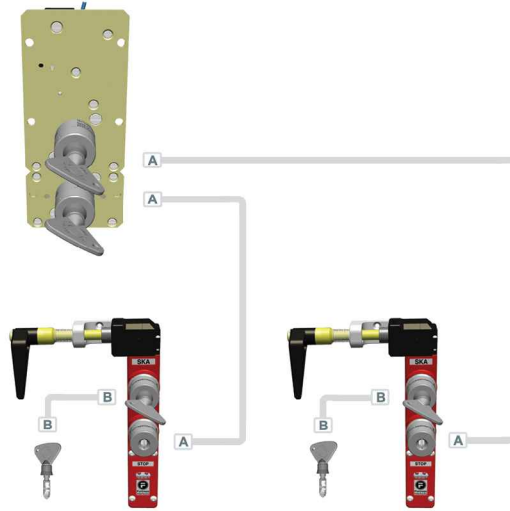

AMS1A1STOP024CLIN

AMS1A1STOP024CLIN



**mGard Application Example IV (electrical switch gear interlocking)**

To prevent paralleling of incoming or busbar power supplies, **mGard** mechanical trapped key systems are used to control safe operation.

In this application example two incoming supply isolators are fitted with BM1 bolt interlocks, allowing only one isolator to be closed (switched "on") at any time.

Each bolt lock is equipped with a blocking device such that when the bolt is shot, the isolator cannot be closed.

Only one key is supplied with this system in order to prevent paralleling of incoming or busbar power supplies.

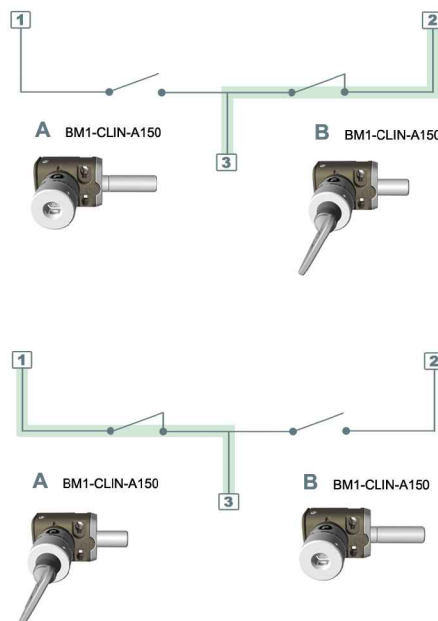

## Power Isolation

### BM



#### Mechanical Bolt Interlock

The BM is used to interlock circuit breakers, valves earth switches etc. It is used where hazards needs to be indirectly interlocked.

- No product handling issues
- 16mm diameter bolt with 16mm of travel
- Extended bolt lengths available
- Standard operation: Key free, bolt shot (other sequences available)
- Additional modules/keys can be added

*This product may not be used as an access lock.*

#### Product Types

| N° of Locks                                  | Ref N°      |
|--|-------------|
| 1 » 10                                       | BM1 » BM10  |
| N° of Locks (Full Stainless Steel)           | Ref N°      |
| 1 » 5  | BMS1 » BMS5 |
| Lock Type                                    |             |
| For key and lock specifications view page 12 |             |
| Bolt Lengths                                 | Ref N°      |
| 6.35mm                                       | -           |
| 50mm extension                               | 50          |
| 150mm extension                              | 150         |

### BML



#### Bolt Interlock with Limit Switch

This device is used to interlock circuit breakers, valves, earth switches etc. It additionally provides electrical indication of the bolt position.

- No product handling issues
- 16mm diameter bolt with 16mm of travel
- Extended bolt lengths available
- Standard operation: Key Free, bolt shot (other sequences available)
- Standard IP67 switch
- Additional modules/keys can be added

*This product may not be used as an access lock.*

#### Product Types

| N° of Locks                                  | Ref N°        |
|--|---------------|
| 1 » 4  | BML1 » BML4   |
| N° of Locks (Full Stainless Steel)           | Ref N°        |
| 1 » 4  | BMSL1 » BMSL4 |
| Switch Current                               | Ref N°        |
| 3A   | -             |
| Switch Contacts                              | Ref N°        |
| 1NO / 1NC                                    | -             |
| Lock Type                                    |               |
| For key and lock specifications view page 12 |               |
| Bolt Lengths                                 |               |
| See BM specification                         |               |

### BMR

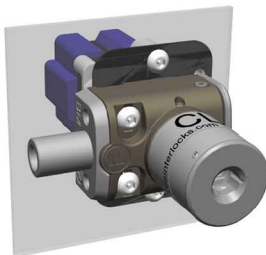

#### Bolt Interlock with Switch

This device is used to interlock circuit breakers, valves, earth switches etc. It additionally provides electrical indication of the bolt position.

- No product handling issues
- 16mm diameter bolt with 16mm of travel standard (extended bolt lengths available)
- Standard operation: Key free, bolt shot (other sequences available)
- Special switch ratings and/or contact arrangements available on request
- Additional modules/keys can be added
- Each key can be monitored using 20A or 32A switches

*This product may not be used as an access lock.*

#### Product Types

| N° of Locks                                  | Ref N°        |
|--|---------------|
| 1 » 10                                       | BMR1 » BMR10  |
| N° of Locks (Full Stainless Steel)           | Ref N°        |
| 1 » 5  | BMSR1 » BMSR5 |
| Lock type                                    |               |
| For key and lock specifications view page 12 |               |
| Switch Current                               | Ref N°        |
| 20A  | 020           |
| 32A  | 032           |
| 63A  | 063           |
| Switch Contacts                              | Ref N°        |
| 4NO / 0NC                                    | 40            |
| 2NO / 2NC                                    | 22            |
| Bolt Lengths                                 | Ref N°        |
| See BM specification                         |               |

### AC090AB



#### Circuit Breakers

When mounted on the front of the circuit breaker, this lock allows or prevents switching of the breaker.

- All circuit breakers make and type must be specified

#### Product Types

| Breaker Type                        | Ref N°       |
|-------------------------------------|--------------|
| ABB (SACE EMAX)                     | CLIN-AC090AB |
| Merlin Gerin (Masterpact)           | CLIN-MC090MG |
| Siemens (3WL)                       | CLIN-X002    |
| Key type                            |              |
| For key specifications view page 12 |              |

#### Bolt Interlocks

For isolation of existing machinery or equipment, Fortress bolt interlocks are a simple mechanical solution to guarantee a safe work place, without the need for wiring. The robust design for both keys and locks can withstand harsh environments, such as dust, moisture and vibration.





Control Isolation

**S**

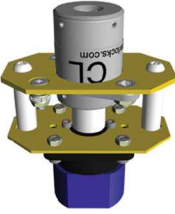

CCC UL US SP switch approval

**Key Switch**

The S(E) unit is suitable for isolation or switching current and may be used to isolate power to machinery.

- Direct drive operation - positively opens contacts
- The standard sequence is: Key trapped (but not locked) - Power on, Key free - Power off (other sequences to be specified)
- Special switch ratings and/or contact arrangements available on request
- Enclosed version (SE) in Polycarbonate (IP66)

**Product Types**

|  |        |
|--|--------|
| <u>Mounting</u>                              | Ref N° |
| Back of Board                                | S      |
| In Enclosure (IP66)                          | SE     |
| <u>Lock Type</u>                             |        |
| For key and lock specifications view page 12 |        |
| <u>Switch Current</u>                        | Ref N° |
| 20A  | A020   |
| 32A  | A032   |
| 63A  | A063   |
| <u>Switch Contacts</u>                       | Ref N° |
| 4NO / 0NC                                    | 40     |
| 2NO / 2NC                                    | 22     |

**SS**



CCC UL US SP switch approval

**Solenoid Controlled Key Switch**

The SS unit is used where the key(s) need to remain trapped until an electrical signal has been received.

- Direct drive operation - positively opens contacts
- Suitable for machines with a rundown cycle
- The standard sequence is: Solenoid de-energised - Key trapped, Solenoid energised - Key free, (other sequences available)
- Special switch ratings, solenoid voltage and/or contact arrangements available on request
- Solenoid monitoring contacts as standard
- Enclosed version (SS-F) in Polycarbonate (IP66)

**Product Types**

|  |             |
|--|-------------|
| <u>N° of Locks</u>                           | Ref N°      |
| 1 » 8  | SS1 » SS8   |
| <u>Lock type</u>                             |             |
| For key and lock specifications view page 12 |             |
| <u>Switch Current</u>                        | Ref N°      |
| 20A  | A020        |
| 32A  | A032        |
| 63A  | A063        |
| <u>Switch Contacts</u>                       | Ref N°      |
| 4NO / 0NC                                    | 40          |
| 2NO / 2NC                                    | 22          |
| <u>Solenoid Voltage</u>                      | Ref N°      |
| 24V DC                                       | D024        |
| 110V AC / 110V DC                            | A110 / D110 |
| <u>Mounting</u>                              | Ref N°      |
| Back of Board                                | B           |
| In Enclosure (IP66)                          | F           |

**FLP**



Ex II 2GD EExd IIB T4-T6

**ATEX Key Switch**

A key switch for use in areas where explosive/flammable gases or dust particles may be present.

- Direct drive operation - positively opens contacts
- The standard sequence is: Key trapped (but not locked) - Power on, Key free - Power off (other sequences to be specified)
- Special switch ratings and/or contact arrangements available on request

**Product Types**

|  |        |
|--|--------|
| <u>Mounting</u>                              | Ref N° |
| In Enclosure (IP65)                          | FLP    |
| <u>Lock type</u>                             |        |
| For key and lock specifications view page 12 |        |
| <u>Switch Current</u>                        | Ref N° |
| 20A  | A020   |
| 32A  | A032   |
| 63A  | A063   |
| <u>Switch Contacts</u>                       | Ref N° |
| 4NO / 0NC                                    | 40     |
| 2NO / 2NC                                    | 22     |

**EEXSS1**



Ex ATEX Ex II 2G Ex d IIC T6

**ATEX Solenoid Controlled Key Switch**

A solenoid key switch for use in areas where explosive, flammable gases or dust particles may be present.

- Direct drive operation - positively opens contacts
- The standard sequence is: Solenoid de-energised - Key trapped, Solenoid energised - Key free, (other sequences available)
- Special switch ratings, solenoid voltage and/or contact arrangements available on request.
- Solenoid monitoring contacts as standard

**Product Types**

|  |             |
|--|-------------|
| <u>Mounting</u>                              | Ref N°      |
| In Enclosure (IP66)                          | EEXSS1      |
| <u>Lock type</u>                             |             |
| For key and lock specifications view page 12 |             |
| <u>Switch Current</u>                        | Ref N°      |
| 20A  | A020        |
| 32A  | A032        |
| <u>Switch Contacts</u>                       | Ref N°      |
| 4NO / 0NC                                    | 40          |
| 2NO / 2NC                                    | 22          |
| <u>Solenoid Voltage</u>                      | Ref N°      |
| 24V DC                                       | D024        |
| 110V AC / 110V DC                            | A110 / D110 |

**Solenoid Controlled Key Switch**

The device is used where the key(s) need to remain trapped until an electrical signal has been received. (e.g. for machine rundown time or cycle end)



**SLS** CCC<sup>e</sup> UL<sup>US</sup> SPB switch approval



**Solenoid Controlled Key Switch Unit**

This device ensures that keys may not be released until both the solenoid has been energised and the control power has been isolated.

- Suitable for machines with a rundown cycle
- Fortress key operated override facility for mechanical release of the keys
- LED status indication

**Product Types**

|  |             |
|--|-------------|
| N° of Locks (excl. override lock)            | Ref N°      |
| 1 » 6  | SLS1 » SLS6 |
| <b>Lock type</b>                             |             |
| For key and lock specifications view page 12 |             |
| Switch Current                               | Ref N°      |
| 10A  | A010        |
| Switch Contacts                              | Ref N°      |
| 2NO / 2NC                                    | 22          |
| Solenoid Voltage                             | Ref N°      |
| 24V DC                                       | D024        |
| 110V AC / 110V DC                            | A110 / D110 |

**TD** Standard  
**TR** Remotely operated  
**TS** Key operated  
CCC<sup>e</sup> UL<sup>US</sup> SPB switch approval



**Electronic Time Delay Unit**

The TD unit releases keys at the end of a pre-determined time period.

- Direct drive operation - positively opens contacts
- Suitable for machines with a rundown cycle
- Enclosures in Polycarbonate (IP65) as standard
- Special switch ratings, solenoid voltage and/or contact arrangements available on request
- Solenoid monitoring contacts as standard
- Remotely (TR) and key operated (TS) version available on request

**Product Types**

|  |             |
|--|-------------|
| N° of Locks                                  | Ref N°      |
| 1 » 3  | TD1 » TD3   |
| <b>Lock type</b>                             |             |
| For key and lock specifications view page 12 |             |
| Switch Current                               | Ref N°      |
| 20A  | A020        |
| 32A  | A032        |
| 63A  | A063        |
| Switch Contacts                              | Ref N°      |
| 4NO / 0NC                                    | 40          |
| 2NO / 2NC                                    | 22          |
| Solenoid Voltage                             | Ref N°      |
| 24V DC                                       | D024        |
| 110V AC / 110V DC                            | A110 / D110 |
| Time Delay Up To                             | Ref N°      |
| 5 Min  | 05          |
| 30 Min                                       | 30          |

**VS** CCC<sup>e</sup> UL<sup>US</sup> SPB switch approval



**Voltage Sensing Unit**

Releases key(s) after zero voltage detection of the induced voltage (Back EMF) of a motors windings.

- Direct drive operation - positively opens contacts
- Permits access as soon as the machine comes to rest
- No additional "timer safety margin" required
- Suitable for machines with a rundown cycle
- Enclosures in Polycarbonate (IP65) as standard
- Special switch ratings, solenoid voltage and/or contact arrangements available on request
- Solenoid monitoring contacts as standard

**Product Types**

|  |        |
|--|--------|
| N° of Locks                                  | Ref N° |
| 1  | VS1    |
| <b>Lock type</b>                             |        |
| For key and lock specifications view page 12 |        |
| Switch Current                               | Ref N° |
| 20A  | -      |
| Switch Contacts                              | Ref N° |
| 2NO / 2NC                                    | -      |
| Solenoid Voltage                             | Ref N° |
| 24V AC                                       | 024    |
| 110V AC                                      | 110    |
| 230V AC                                      | 230    |

**ODS** Knob operated  
**ODL** Key operated  
CCC<sup>e</sup> UL<sup>US</sup> SPB switch approval

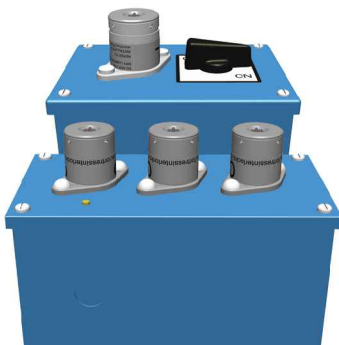

**Knob/Key Operated Switch Control Unit**

The ODS Releases key(s) after switching the knob into a visible off position.

The ODL is a 'key bank' with a switch. It incorporates one or more rotary switches and any combination of trapped or freed keys.

- Direct drive operation - positively opens contacts
- Mild steel enclosure as standard
- Stainless steel enclosure as standard in combination with CLSS or MLSS lock types
- Special switch ratings and/or contact arrangements available on request

**Product Types**

|  |                     |
|--|---------------------|
| Operation Type                               | Ref N°              |
| Knob operated                                | ODS                 |
| Key operated                                 | ODL                 |
| N° of Locks Released or Trapped              | Ref N°              |
| 1 » 8  | OD(S/L)1 » OD(S/L)8 |
| <b>Lock type</b>                             |                     |
| For key and lock specifications view page 12 |                     |
| Vertical/Horizontal                          | Ref N°              |
| Vertical                                     | V1                  |
| Horizontal                                   | H1                  |
| Linking System                               | Ref N°              |
| Cams (stainless steel)                       | C(S)                |
| Runnerbar (stainless steel)                  | R(S)                |
| Mounting                                     | Ref N°              |
| Back of Board                                | B                   |
| In Enclosure                                 | F                   |
| Switch Current                               | Ref N°              |
| 20A  | A020                |
| 32A  | A032                |
| 63A  | A063                |
| 150A (ODS only)                              | A150                |
| Switch Contacts                              | Ref N°              |
| 4NO / 0NC                                    | 40                  |
| 2NO / 2NC                                    | 22                  |

**Key Exchange**

**XM**



**Modular Key Exchange Unit**

The XM unit is used to exchange one or more keys for a number of other keys. This device forms the link between isolation devices and access locks.

- No product handing issues
- Extremely varied combination of isolation/access keys possible
- Sequential or Non-sequential key operation
- Simply add modules to existing configurations

**Product Types**

| N° of Locks                        | Ref N°      |
|------------------------------------|-------------|
| 2 » 10                             | XM2 » XM10  |
| N° of Locks (Full Stainless Steel) | Ref N°      |
| 2 » 5                              | XMS2 » XMS5 |

Lock type

For key and lock specifications view page 12

**XMR**

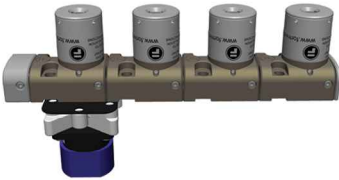

**Modular Key Exchange Unit with Switch**

Besides exchanging one or more keys for a number of other keys the XMR is additionally fitted with rotary switch(es) that can be used for power or control isolation.

- No product handing issues
- Extremely varied combination of isolation/access keys possible
- Sequential or Non-sequential key operation
- Simply add modules to existing configurations
- Enclosed version (XMR-E) in Polycarbonate (IP67)
- Each key/lock can be fitted with a 20A or 32A rotary switch

**Product Types**

| N° of Locks                        | Ref N°        |
|------------------------------------|---------------|
| 1 » 10                             | XMR1 » XMR10  |
| N° of Locks (Full Stainless Steel) | Ref N°        |
| 1 » 5                              | XMSR1 » XMSR5 |

Lock type

For key and lock specifications view page 12

| Switch Current | Ref N° |
|----------------|--------|
| 20A            | A020   |
| 32A            | A032   |
| 63A            | A063   |

| Switch Contacts | Ref N° |
|-----------------|--------|
| 4NO / 0NC       | 40     |
| 2NO / 2NC       | 22     |

| Mounting                | Ref N° |
|-------------------------|--------|
| Sealed Enclosure (IP67) | -E     |
| Back of Board           | -P     |

**Door Locks**

**DM1**



**Single Door Interlock**

- No product handing issues:  
*4 head rotation angles with an adjustment of 360° at 90° increments with +/- 5° fine adjustment*  
*Two actuator entry points*
- All DM locks have stainless steel heads
- Tamper resistant head mechanism
- Choice of actuators

**Product Types**

| N° of Locks                        | Ref N° |
|------------------------------------|--------|
| 1                                  | DM1    |
| N° of Locks (Full Stainless Steel) | Ref N° |
| 1                                  | DMS1   |

Lock type

For key and lock specifications view page 12

**DM**



**Multiple Modular Door Interlock**

- No product handing issues:  
*4 head rotation angles with an adjustment of 360° at 90° increments with +/- 5° fine adjustment*  
*Two actuator entry points*
- Extremely varied combination of isolation/access keys possible
- Sequential or Non-sequential key operation
- Simply add modules to existing configurations
- All DM locks have stainless steel heads
- Tamper resistant head mechanism
- Choice of actuators

**Product Types**

| N° of Locks                        | Ref N°      |
|------------------------------------|-------------|
| 2 » 10                             | DM2 » DM10  |
| N° of Locks (Full Stainless Steel) | Ref N°      |
| 2 » 5                              | DMS2 » DMS5 |

Lock type

For key and lock specifications view page 12



**DM Handling Options**

The DM and DMS modules benefit from a revolutionary new head design. With six actuators to choose from, the head features a choice of four head rotation angles and two actuator entry points with an adjustment of 360° at 90° increments with +/- 5° fine adjustment.



**Actuators**

**DM-F** \* -F in part N°



**Fixed Actuator**

- For use with all DM type locks
- Ideal for most aligned guarding doors
- Compact (fits within DM body's space envelope)
- Version with chain available (DM-F-chain)

**DM-H** \* -H in part N°



**Handle Operated Actuator**

- For use with all DM type locks
- Suitable for use where secondary action is required
- Overcomes misalignment
- Vertical adjustment: +/- 6mm
- Rotational adjustment of bracket, to suit all four DM handling options
- Detent holds actuator in place when the door is open

**DM-A** \* -A in part N°



**Spring Loaded Handle Operated Actuator**

- For use with all DM type locks
- Suitable for use where secondary action is required
- Overcomes misalignment
- Vertical adjustment: +/- 6mm
- Rotational adjustment of bracket, to suit all four DM handling options
- Detent holds actuator in place when the door is open

**DM-S** \* -S in part N°



**Self Aligning Actuator**

- For use with all DM type locks
- Ideal for small radius hinged doors
- Horizontal adjustment: +/- 7.50mm
- Vertical adjustment: +/- 3.75mm
- Rotational adjustment: any angle in 360°

**DM-C** \* -C in part N°

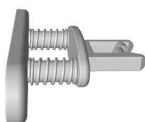

**Compressible Actuator**

- For use with all DM type locks
- Ideal to absorb vibration on hatches/doors
- Can be used on small radius hinged doors
- Suitable for situations where the door is likely to be slammed

Accessories

|                      |  |   |                  |        |          |     |                      |      |
|----------------------|--|---|------------------|--------|----------|-----|----------------------|------|
| <b>XMA</b>           | <p><b>Extension Module</b></p> <ul style="list-style-type: none"> <li>For adding lock units onto existing BM, BMR, XM, XMR, DM and DMR configurations</li> </ul> | <p><b>Product Types</b></p> <table border="1"> <tr> <td>Housing Material</td> <td>Ref N°</td> </tr> <tr> <td>Standard</td> <td>XMA</td> </tr> <tr> <td>Full Stainless Steel</td> <td>XMSA</td> </tr> </table> <p>Lock type<br/>For key and lock specifications view page 12</p> | Housing Material | Ref N° | Standard | XMA | Full Stainless Steel | XMSA |
| Housing Material     | Ref N°   |   |                  |        |          |     |                      |      |
| Standard             | XMA  |   |                  |        |          |     |                      |      |
| Full Stainless Steel | XMSA   |   |                  |        |          |     |                      |      |



|                  |  |   |                  |        |          |      |
|------------------|--|---|------------------|--------|----------|------|
| <b>MBOB</b>      | <p><b>Back of Board Mounting Kit</b></p> <ul style="list-style-type: none"> <li>To provide back of board mounting possibilities for BM, BMR, XM, XMR, DM and DMR configurations</li> </ul> <p><i>Not suitable for use onto full stainless steel configurations</i></p> | <p><b>Product Types</b></p> <table border="1"> <tr> <td>Housing Material</td> <td>Ref N°</td> </tr> <tr> <td>Standard</td> <td>MBOB</td> </tr> </table> | Housing Material | Ref N° | Standard | MBOB |
| Housing Material | Ref N°   |   |                  |        |          |      |
| Standard         | MBOB   |   |                  |        |          |      |



Lock and Key Specifications

Fortress locks have over 200,000 different lock combinations. Besides the standard basic (CL) it is also possible to have a master series (ML) lock. The ML lock which can be operated by a special cut master key (MLK-SUGS) that fits any mastered lock in a specific mastered lock series. For ease of use all Fortress locks provide key insertion in two orientations.

Lock and key engravings

Each different key combination is allocated with an engraved code onto the lock and key, of up to maximum 30 characters (3 lines of 10 characters). This engraving code is used to identify locks and keys and is recorded in a database for continuous cross reference. Required engraving details are therefore to be provided with each order.

|                 |   |   |  |  |
|-----------------|---|---|--|--|
| <b>Standard</b> | <p><b>CLIN lock</b><br/>Standard CL lock no dustcover</p>   | <p><b>CLIS lock</b><br/>Standard CL lock with stainless steel dustcover</p>   | <p><b>CLSS lock</b><br/>Full Stainless Steel CL lock with stainless steel dustcover</p>            | <p><b>CLK-SUS</b><br/>Standard key for use on all CL lock types</p> <p><b>CLK-LP</b><br/>Standard low profile key for use on all CL lock types</p> |
| <b>Master</b>   | <p><b>MLIN lock</b><br/>Masterable ML lock no dustcover</p> | <p><b>MLIS lock</b><br/>Masterable ML lock with stainless steel dustcover</p> | <p><b>MLSS lock</b><br/>Full Stainless Steel masterable ML lock with stainless steel dustcover</p> | <p><b>MLK-SUGS</b><br/>Standard cut key for use on all ML type locks</p> <p><b>MLK-SUCM</b><br/>Master cut key for use on all ML lock types</p>    |

As an option Fortress locks can also be supplied with Padlockable dustcovers, that incorporates two padlock holes which can be fitted with lockout hasps and scissor hasps between 3mm and 8mm in diameter as shown below.

|                          |  |  |   |
|--------------------------|--|--|---|
| <b>Dustcover Options</b> | <p><b>CLDC</b> Stainless Steel Dustcover</p> | <p><b>PLDC</b> Stainless Steel Padlockable Dustcover</p> | <p><b>LOS3</b> Lock-Out Scissor Hasp<br/><b>LOS3C</b> Lock-Out Scissor Hasp c/w Cable</p> |
|--------------------------|--|--|---|

Key and lock engravings

Maximum 30 characters  
(3 lines of 10 characters)





**amGard** is the ultimate range of modular safety gate switch interlocks, for heavy duty applications. Its modular construction allows easy configuration. **amGard** provides total electro-mechanical solutions for practically any safeguarding application up to SIL3 (EN/IEC 62061), Category 4 and PL<sub>e</sub> (EN/ISO 13849-1).

By its unique design concept, **amGard** offers a fully integrated safety switch controlled closing and/or locking system, designed for strength and reliability in hazardous operating conditions.

The **amGard** system replaces all adaptations normally fitted within a guarding system. Additional arrangements like actuators/operators, catches, internal release functions, trapped key functions and deadlocks are no longer needed. All of these separate functions are or can simply be incorporated into the **amGard** configurations



|                                |   |   |   |                                |
|--------------------------------|---|---|---|--------------------------------|
| Head Modules                   |    | <p><b>Head Modules, Actuators &amp; Cap</b><br/> <i>Handle Actuator &amp; Head<br/>             Tongue Actuator &amp; Head<br/>             Lock-Out Clips<br/>             Slidebars<br/>             Mechanical Cap (for non door lock configurations)</i></p>  |    | Head Modules                   |
| Adaptors                       |   | <p><b>Adaptors &amp; Foot</b><br/> <i>Safety Key Adaptor<br/>             Access Key Adaptor<br/>             Internal Release Adaptor<br/>             Padlock Adaptor<br/>             Foot (to terminate mechanical lock)</i></p>  |   | Adaptors                       |
| Electrical Switching / Locking |  | <p><b>Electrical Switching / Locking</b><br/> <i>Safety Switch Bodies<br/>             Solenoid Controlled Lock Bodies<br/>             Explosion Proof Switch Bodies</i></p> <p><br/> <i>AS-interface versions available<br/>             European, Canadian and North American approvals</i></p> |  | Electrical Switching / Locking |
| Option PODs                    |  | <p><b>Option PODs</b><br/> <i>Key Switch Option Pod<br/>             Indicator Lamp Option Pod<br/>             Pushbutton Option Pod</i></p> <p><br/> <i>AS-interface versions available<br/>             European, Canadian and North American approvals</i></p>                                 |   | Electrical Switching / Locking |

**Select and Configure your Solutions**

The basic assemblies ATSTOP, ATLOK and AMSTOP, AMLOK are only a selection of the configurations to suit basic heavy duty safety gate switch requirements. By selection of optional modules these configurations can easily be extended with the required functions.

**amGard** composes dual channel safety circuits to allow cross monitoring, the robust stainless steel actuator with a self-adjusting operation provides a long life cycle and reduction of down time and maintenance. Specially designed for harsh environments, the **amGard** range is ideal for use in areas with dust and moisture and is tested to over 1,000,000 operations.

**amGard** trapped key modules are fully interchangeable with the Fortress **mGard** range of trapped key interlocks.

**amGard Application Example I**

This example shows the safeguarding of robot areas in which **amGard** products offer a combined mechanical and electrical solution.

**1 CPS2LOK024024B CLIN**

By pressing the access request button, the machine or installation is shut down, by the machine control system.

The solenoid, controlled by the machine control system restricts the release of keys A until the guarded area or machine is safe to enter (indicated by the yellow status LEDs).

Energising the solenoid breaks the dual safety circuits to prevent unexpected re-start.

Both safety keys A can now be released indicated by the red status LED.

**2 AM & SBNS1A1FOOT CLIN**

Keys A can be used to unlock the door locks and release the safety keys B. These can be taken inside the guarded area to prevent personnel being trapped and/or an accidental machine restart.

By reversing this compulsory procedure the machine can safely be restarted.

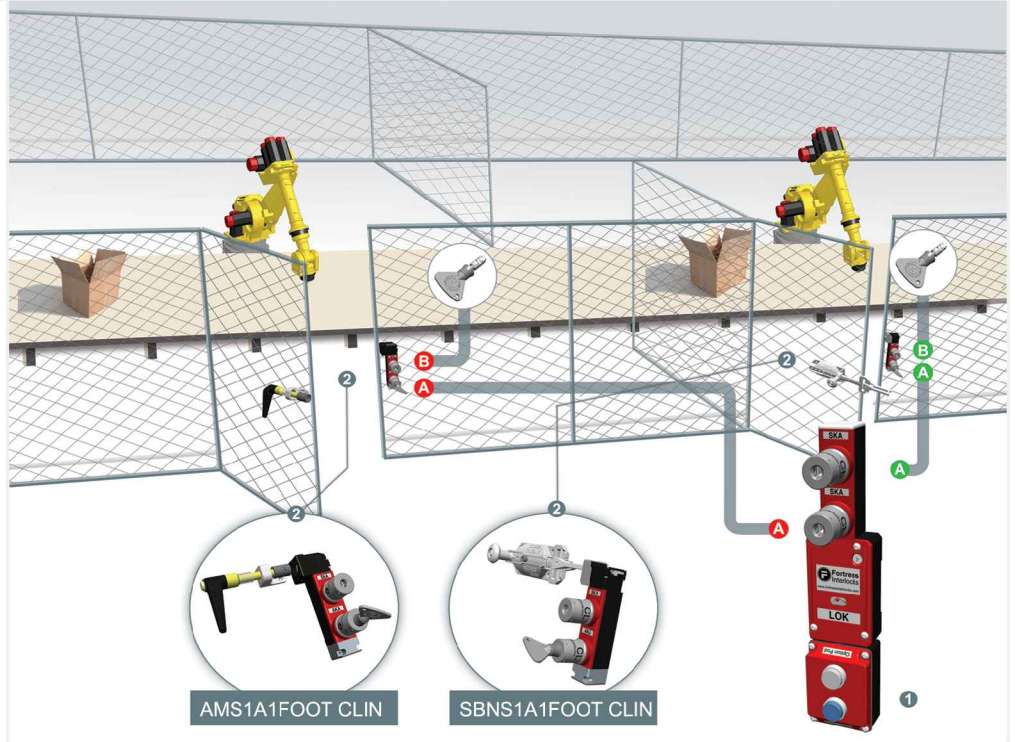

**amGard Application Example II**

This example shows the safeguarding of a potentially dangerous area with a teach mode function inside.

**1 SBNLOK024024K CLIN**

Removal of the key from one of the pods at the doors selects machine stop at the end of a run down cycle. The solenoid is then energised by the machine control system and access can be gained.

The operator can take the safety key into the potentially hazardous area preventing restart.

**2 PODK CLIN**

By inserting one of the keys in the stand alone pod inside the guarded area safe programming can be initiated

**3 SBILOK024024IRK CLIN**

The LOK internal release option can be used to unlock the door from inside a guarded area should personnel become trapped. By pushing the button on the rear of the unit, the tongue is released from the actuator head and the door can be opened from the inside. This also breaks both safety circuits, which then have to be manually reset before the machine can re-start.

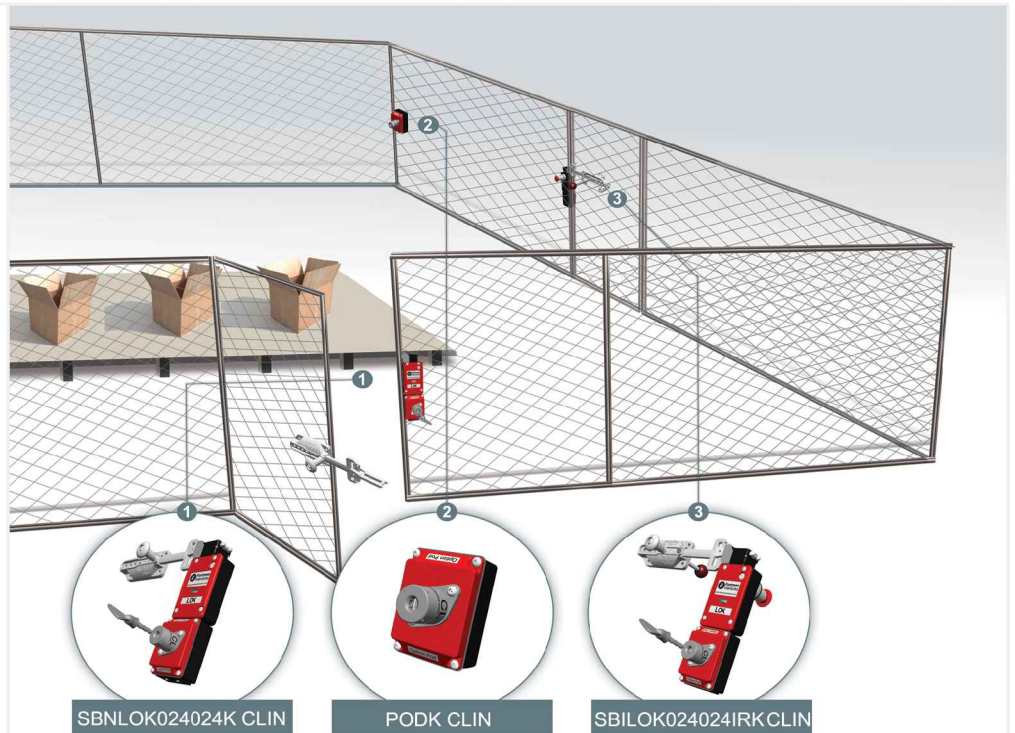



Head Modules & Actuators

Add-Ons

AM

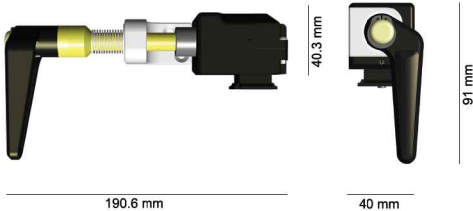

AM Handle Actuator & Head

- Heavy duty handle unit
- 4 position fixing at 90° increments
- Operating handle can be rotated in 45° increments
- Allows for guard misalignment
- Retention force 2500N
- Can be fitted with lock-out devices for additional safety

Head (AMH) and Handle (AMK) also available separately.

AM Lock-Out Clip

Once inserted into the head and padlocked in position, it blocks the handle entry preventing the door being closed and the machine from being restarted.



AML

AT

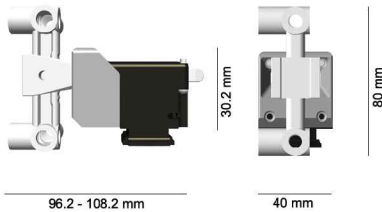

AT Tongue Actuator & Head

- Heavy duty tongue unit
- Ideal for fast, frequent access
- 4 position fixing at 90° increments
- Misalignment tolerance of +/- 12mm
- Retention force 2500N
- Can be fitted with lock-out devices for additional safety

Head (ATH) and Tongue (ATK) also available separately.

AT Lock-Out Clip

Once inserted into the head and padlocked in position, it blocks the tongue entry preventing the door being closed and the machine from being restarted.



ATL

- SBN** no spring & no internal release
- SBS** spring loaded
- SBI** internal release

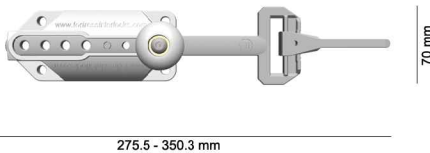

Slidebar

- Used in conjunction with the "ATH head"
- Particular useful for applications using small radius, hinged doors
- Stainless steel casting
- Built in lock-out facility to accommodate a maximum of 4 padlocks with up to 8 mm diameter shackles

Spring loaded version (SBS) is advised when exposed to vibration

CP

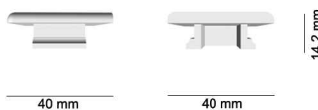

Cap

Suitable for use with the adaptor products

- Protects the unit from debris
- Removable to enable reconfiguration

Hinged door equipped with SBISTOP024 configuration





**Adaptors**

**IRA**

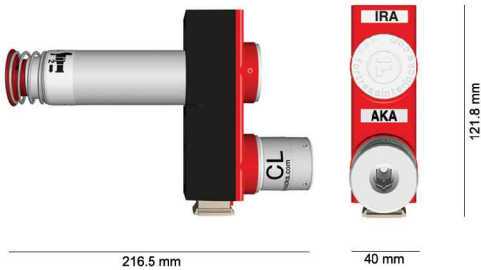

**Internal Release Adaptor**

Overrides the safety or access key mechanism and provides a means of escape from inside the guarded area.

- If incorporated into a STOP body the internal release mechanism puts the machine into a stop
- Always in combination with A1, S1, LO or LT
- Up to 5 key adaptors in one configuration

*For key and lock specifications view page 22.  
Keys must be ordered separately.  
Cannot be used in combination with LOK type bodies.*

**S1**

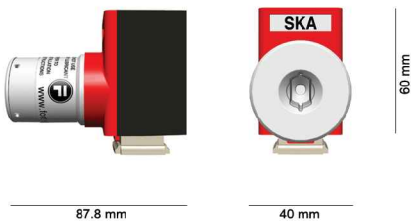

**Safety Key Adaptor**

This unit ensures that machine/process cannot be restarted without returning the key(s). It can furthermore prevent personnel being accidentally locked inside a guarded area.

- Can be stacked or combined with other adaptors
- Provides unique link to mGard range
- Up to 5 key adaptors (S1»S5) in one configuration

*For key and lock specifications view page 22.  
Keys must be ordered separately.*

**A1**

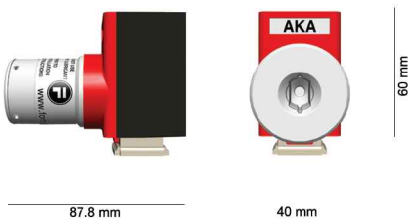

**Access Key Adaptor**

Ideally suited for authorised access only, or linked access to other machinery.

- Ensures a specific sequence of operation
- Can be stacked or combined with other adaptors
- Provides unique link to mGard range
- Up to 5 key adaptors (A1»A5) in one configuration

*For key and lock specifications view page 22.  
Keys must be ordered separately.*

**amGard Application Example III**

**Safeguarding an area where there is no fencing (e.g. an area protected by a light curtain) or, the guarding has mechanical door locks.**

This amGard configuration enables personnel to work inside potentially dangerous areas (CPS3LOK02024B CLIN). When no fencing exists personnel always remains responsible for their own safety and the possession of the safety key is their safety guarantee.

Access is requested by pressing the red button on the Option POD module. When the area is safe to enter, the solenoid controlled safety switch is energised and the safety keys can be released in sequence. Personnel can keep these keys with them, to prevent machine restart, or use these to open the mechanical door locks (in case of a fenced area). Only when all keys are back in the safety key adaptors can the machine be restarted.



**LO**

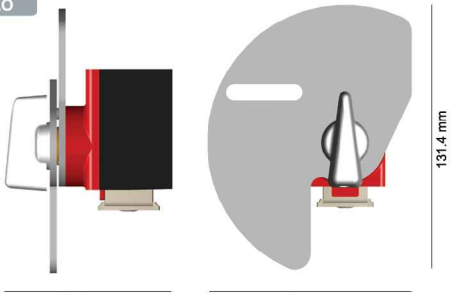

**Single Lock-Out Padlock Adaptor**

Provides padlocking only in one position.

- Provides a link with other lock-out tag-out safety procedures
- Accommodates up to 5 padlocks with 7.5mm diameter shackles
- Facilitates enhanced supervisor security

**LT**



**Dual Lock-Out Padlock Adaptor**

This unit is equipped with two padlock positions for use as a voluntary lock-out facility.

- Provides a link with other lock-out tag-out safety procedures
- Accommodates one padlock with 8mm diameter shackles
- Enables quick and easy access

**FOOT**

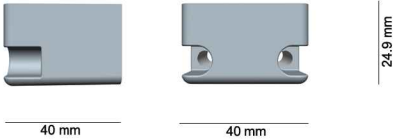

**Foot**

To terminate all non-switch configurations.

- Secures unit firmly to mounting surface
- Removable to allow for modification

**amGard Application Example IV**

ATIRA1STOP024 MLIS, a tongue operated safety switch with internal release function requiring access key to be inserted to safely enter the guarded area.

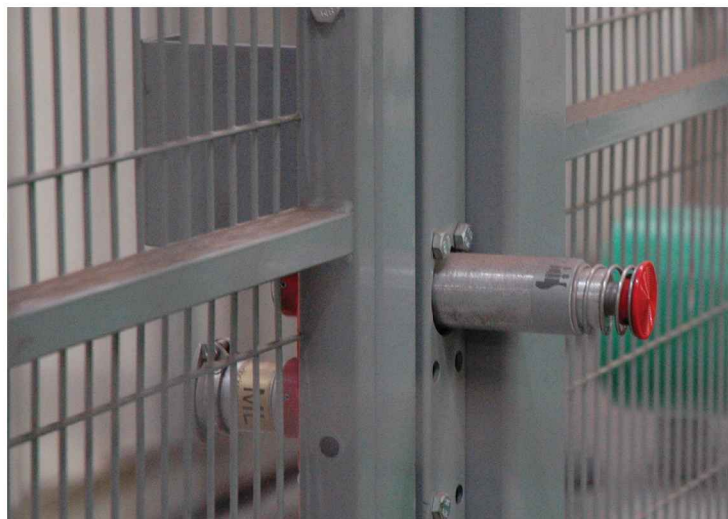
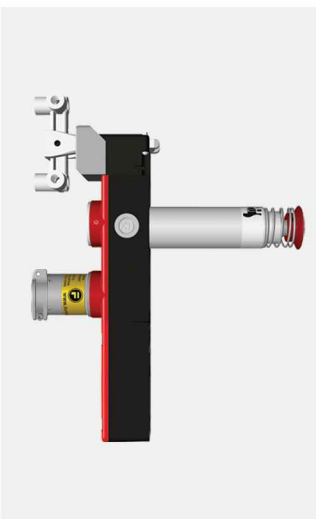

**Electrical Switching/Locking**

Base units are the electromechanical elements of the heavy duty modular **amGard** range that interface with safety relays and PLC's providing controlled access to machinery or a guarded area. Tested to over 1 million operations these units contain dual channel safety circuitry making them suitable for use in applications up to SIL3 (EN/IEC 62061) Category 4 and PLe (EN/ISO 13849-1).

**STOP**

40 mm      40 mm      100 mm

**Safety Switch Body**

The STOP unit breaks the dual safety circuits to select machine stop and/or monitoring access.

- Ideal for quick access to machines with no or short run-down cycles
- Non-solenoid controlled
- LED indicators for status identification
- European, Canadian and North American approvals

*STOP AS-i is supplied in a LOK size housing type.*

**Product Types**

| Control      | Ref N°  |
|--------------|---------|
| 24V AC/DC    | STOP024 |
| 110V AC      | STOP110 |
| 230V AC      | STOP230 |
| AS-Interface | STOPASI |

**LOK** power to unlock  
**LOKPL** power to lock

43 mm      80 mm      130 mm

**Solenoid Controlled Lock Body**

Energising (LOK) or de-energising (LOKPL) the solenoid breaks the dual safety circuits to prevent access until machine/area is safe.

- Ideal for machines with run-down cycles
- LED indicators for status identification
- Solenoid override facility for increased safety in the event of power failure (not applicable for the power to lock version)
- Split voltage available on request
- European, Canadian and North American approvals

**Product Types**

| Control / Solenoid     | Ref N° LOK   |
|------------------------|--------------|
| 24V AC/DC / 24V AC/DC  | LOK024024    |
| 110V AC / 110V AC      | LOK110110    |
| 230V AC / 230V AC      | LOK230230    |
| Control / Solenoid     | Ref N° LOKPL |
| 24V AC/DC / 24V AC/DC  | LOK024024PL  |
| 110V AC / 110V AC      | LOK110110PL  |
| AS-i "power to unlock" | LOKASI       |
| AS-i "power to lock"   | LOKASIPL     |

**LOKIR** power to unlock  
**LOKPLIR** power to lock

102.8 mm      80 mm      130 mm

**Solenoid Safety Switch with Internal Release**

This unit is equipped with an additional internal release button for a mechanical override function of the solenoid switch.

- LED indicators for status identification
- Prevents access until machine is safe
- Solenoid override facility for increased safety in the event of power failure (not applicable for the power to lock version)
- Split voltage available on request
- European, Canadian and North American approvals

**Product Types**

| Control / Solenoid     | Ref N° LOKIR   |
|------------------------|----------------|
| 24V AC/DC / 24V AC/DC  | LOK024024IR    |
| 110V AC / 110V AC      | LOK110110IR    |
| 230V AC / 230V AC      | LOK230230IR    |
| Control / Solenoid     | Ref N° LOKPLIR |
| 24V AC/DC / 24V AC/DC  | LOK024024PLIR  |
| 110V AC / 110V AC      | LOK110110PLIR  |
| AS-i "power to unlock" | LOKASIIR       |
| AS-i "power to lock"   | LOKASIPLIR     |

**STOPTX** ATEX certified  
**STOPXP** UL/CSA certified

72.9 mm      76 mm      171 mm

**Explosion Protected Safety Switch Body**

**STOPTX** : ATEX certified product. Heavy duty explosion protected safety gate switch. Suitable for zone 1 & 2 environments.

**STOPXP** : UL / CSA certified product. Heavy duty explosion protected safety gate switch. Suitable for zone 1 & 2 environments.



Option PODs

Option PODs provide an added control feature for assembled **amGard** units. There are 3 standard types, each serving a specific purpose. Other combinations are available on request.

| Option PODs                                   |  | Key Switch Option POD  | Product Types |        |             |      |                            |         |                       |   |              |         |
|---|--|--|---------------|--------|-------------|------|----------------------------|---------|-----------------------|---|--------------|---------|
| <p><b>PODK</b></p> <p>90.8 mm<br/>82.5 mm</p> | <p><b>Key Switch Option POD</b></p> <p>The removal of the key enables the machine to stop at the end of a rundown cycle. The PODK can additionally be used separately for teach mode activation.</p> <ul style="list-style-type: none"> <li>• Contains 2NO/2NC contact arrangement</li> <li>• Switch rating 3A</li> <li>• Provides a request to stop/start</li> <li>• Can be used as a "stand alone" key switch</li> <li>• European approval</li> </ul> <p><i>For key and lock specifications view page 22. Keys must be ordered separately.</i></p> | <p><b>Product Types</b></p> <table border="1"> <thead> <tr> <th>Description</th> <th>Ref N°</th> </tr> </thead> <tbody> <tr> <td>Stand alone</td> <td>PODK</td> </tr> <tr> <td>For mounting to LOK module</td> <td>LOKPODK</td> </tr> <tr> <td>Mounted to LOK module</td> <td>K</td> </tr> <tr> <td>AS-Interface</td> <td>PODKASI</td> </tr> </tbody> </table> | Description   | Ref N° | Stand alone | PODK | For mounting to LOK module | LOKPODK | Mounted to LOK module | K | AS-Interface | PODKASI |
| Description                                   | Ref N°   |  |               |        |             |      |                            |         |                       |   |              |         |
| Stand alone                                   | PODK   |  |               |        |             |      |                            |         |                       |   |              |         |
| For mounting to LOK module                    | LOKPODK  |  |               |        |             |      |                            |         |                       |   |              |         |
| Mounted to LOK module                         | K  |  |               |        |             |      |                            |         |                       |   |              |         |
| AS-Interface                                  | PODKASI  |  |               |        |             |      |                            |         |                       |   |              |         |
| <p><b>PODL</b></p> <p>63 mm<br/>82.5 mm</p>   | <p><b>Indicator Lamp Option POD</b></p> <p>Ideal complimentary module where multiple interlocks are used for enhanced identification of status.</p> <ul style="list-style-type: none"> <li>• Easy, clear identification of machine status</li> <li>• Can be modified to suit one or two lamps</li> <li>• Standard colours are red and yellow, other colours are available to suit</li> <li>• Illuminated push buttons on request</li> <li>• Combination lamp &amp; pushbuttons units available on request</li> <li>• European approval</li> </ul>    | <p><b>Product Types</b></p> <table border="1"> <thead> <tr> <th>Description</th> <th>Ref N°</th> </tr> </thead> <tbody> <tr> <td>Stand alone</td> <td>PODL</td> </tr> <tr> <td>For mounting to LOK module</td> <td>LOKPODL</td> </tr> <tr> <td>Mounted to LOK module</td> <td>L</td> </tr> <tr> <td>AS-Interface</td> <td>PODLASI</td> </tr> </tbody> </table> | Description   | Ref N° | Stand alone | PODL | For mounting to LOK module | LOKPODL | Mounted to LOK module | L | AS-Interface | PODLASI |
| Description                                   | Ref N°   |  |               |        |             |      |                            |         |                       |   |              |         |
| Stand alone                                   | PODL   |  |               |        |             |      |                            |         |                       |   |              |         |
| For mounting to LOK module                    | LOKPODL  |  |               |        |             |      |                            |         |                       |   |              |         |
| Mounted to LOK module                         | L  |  |               |        |             |      |                            |         |                       |   |              |         |
| AS-Interface                                  | PODLASI  |  |               |        |             |      |                            |         |                       |   |              |         |
| <p><b>PODB</b></p> <p>92 mm<br/>82.5 mm</p>   | <p><b>Pushbutton Option POD</b></p> <p>Ideal for use as an emergency stop or request to start/stop.</p> <ul style="list-style-type: none"> <li>• Request start/stop at the gate</li> <li>• Can be modified to suit one or two pushbuttons</li> <li>• Easy, reliable interface with machine controls</li> <li>• European approval</li> </ul> <p><i>No Emergency-Stop available in AS-I version</i></p>  | <p><b>Product Types</b></p> <table border="1"> <thead> <tr> <th>Description</th> <th>Ref N°</th> </tr> </thead> <tbody> <tr> <td>Stand alone</td> <td>PODB</td> </tr> <tr> <td>For mounting to LOK module</td> <td>LOKPODB</td> </tr> <tr> <td>Mounted to LOK module</td> <td>B</td> </tr> <tr> <td>AS-Interface</td> <td>PODBASI</td> </tr> </tbody> </table> | Description   | Ref N° | Stand alone | PODB | For mounting to LOK module | LOKPODB | Mounted to LOK module | B | AS-Interface | PODBASI |
| Description                                   | Ref N°   |  |               |        |             |      |                            |         |                       |   |              |         |
| Stand alone                                   | PODB   |  |               |        |             |      |                            |         |                       |   |              |         |
| For mounting to LOK module                    | LOKPODB  |  |               |        |             |      |                            |         |                       |   |              |         |
| Mounted to LOK module                         | B  |  |               |        |             |      |                            |         |                       |   |              |         |
| AS-Interface                                  | PODBASI  |  |               |        |             |      |                            |         |                       |   |              |         |

amGard Application Example V

ATLOK024024K CLIN

Removal of the key from the pod selects machine stop at the end of a run down cycle. When the solenoid within the connected gate switch has been energised access can be gained. The operator can take the safety key into the hazardous area preventing restart and/or enable teach mode function by using a stand alone Pod (PODK).

This key can also create a link to the Fortress **mGard** range. By inserting this key into **mGard** mechanical door locks used to lock doors inside the guarded area.



## AMLOK024024 & ATLOK024024

The solenoid controlled safety switch body (LOK) can be equipped with two different head types, creating door/hatch lock configurations that restrict access to the safeguarded area until it is safe to enter.



## AMSTOP024 & ATSTOP024

The safety switch body (STOP) can be equipped with two different head types. These configurations select machine stop and detect the position of doors/hatches that gives access to the safeguarded area or machine.

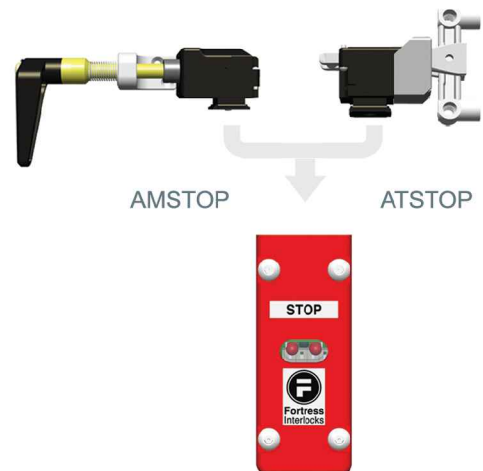

## AmGard Technical Specifications

|   |  |
|---|--|
| Materials                                   | Zinc Alloy to BSEN12844, Stainless Steel to BS3146 |
| Paint Finish                                | Gloss Powder Coat on Passivated Base Material      |
| Colour                                      | Red, Black and Stainless Steel                     |
| Ingress Protection                          | IP67 (DIN 400050)                                  |
| Operating Force                             | 0.5N (AT), 0.1Nm (AM)                              |
| Retention Force Locked                      | 2500N (for all door lock configurations)           |
| Maximum Approach Speed                      | 20m/minutes (for door lock configurations)         |
| Mechanical Life                             | >1,000,000 Switching Cycles                        |
| Maximum Frequency of Ops                    | 7,200/hour   |
| Ambient Temperature                         | -5°C to + 40°C (mean over 24 hrs = +35°C)          |
| Maximum Wire Cross-Section to fit connector | 2.50mm <sup>2</sup>                                |
| Connector Type                              | Spring Activated Vibration Proof Block             |
| Switch Conformance                          | DIN VDE 0660 Part 206 & IEC 647-5-1                |

## Switching Specifications









|                              |   |
|------------------------------|---|
| Switching Principal          | Positive Break (safety circuits)                                  |
| Switch Circuit Current       | 3A  |
| Switching Voltage            | 230V AC Max   |
| Switching Contact Element    | 4NC/2NO (LOK), 2NC/1NO (STOP) and 2NO/2NC (PODK)                  |
| Isolating Distance           | 2 x 2mm per Switch Element  |
| Contact Material             | 90% Silver and 10% Nickel   |
| Utilisation Category         | AC 15 or DC 13  |
| Control Voltage              | 24V AC/DC, 110V AC or 230V AC                                     |
| Insulating Resistance        | 20M 0hm   |
| Insulating Voltage           | 2500V AC  |
| Solenoid Power Rating        | 12W (current at Nominal 24V DC = 500mA. Quasient current = 350mA) |
| Solenoid Rating (Duty Cycle) | 100%  |
| Solenoid Voltage             | 24V AC/DC, 110V AC and 230V AC                                    |
| Solenoid Voltage Tolerance   | 90% to 110% of nominal  |

**Lock and Key Specifications**



Fortress locks have over 200,000 different lock combinations. Besides the standard basic (CL) it is also possible to have a master series (ML) lock. The ML lock which can be operated by a special cut master key (MLK-SUGS) that fits any mastered lock in a specific mastered lock series. For ease of use all Fortress locks provide key insertion in two orientations.

**Lock and key engravings**

Each different key combination is allocated with an engraved code onto the lock and key, of up to maximum 30 characters (3 lines of 10 characters). This engraving code is used to identify locks and keys and is recorded in a database for continuous cross reference. Required engraving details are therefore to be provided with each order.

|          |   |   |   |   |   |  |   |  |
|----------|---|---|---|---|---|--|---|--|
| Standard |  | <b>CLIN lock</b><br>Standard CL lock no dustcover   |  | <b>CLIS lock</b><br>Standard CL lock with stainless steel dustcover   |  | <b>CLSS lock</b><br>Full Stainless Steel CL lock with stainless steel dustcover            |  | <b>CLK-SUS</b><br>Standard key for use on all CL lock types      |
|          |  | <b>MLIN lock</b><br>Masterable ML lock no dustcover |  | <b>MLIS lock</b><br>Masterable ML lock with stainless steel dustcover |  | <b>MLSS lock</b><br>Full Stainless Steel masterable ML lock with stainless steel dustcover |  | <b>MLK-SUGS</b><br>Standard cut key for use on all ML type locks |
|          |   |   |   |   |   |  |  | <b>MLK-SUCM</b><br>Master cut key for use on all ML lock types   |
|          |   |   |   |   |   |  |   |  |

As an option Fortress locks can also be supplied with Padlockable dustcovers, that incorporates two padlock holes which can be fitted with lockout hasps and scissor hasps between 3mm and 8mm in diameter as shown below.

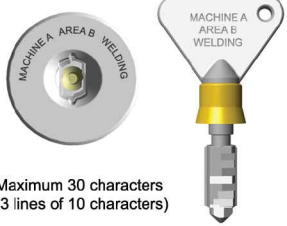
|                   |   |                                       |   |   |  |  |   |
|-------------------|---|---------------------------------------|---|---|--|--|---|
| Dustcover Options |  | <b>CLDC</b> Stainless Steel Dustcover |  | <b>PLDC</b> Stainless Steel Padlockable Dustcover |  | <b>LOS3</b> Lock-Out Scissor Hasp            | <br>Key and lock engravings<br>Maximum 30 characters<br>(3 lines of 10 characters) |
|                   |   |                                       |   |   |  | <b>LOS3C</b> Lock-Out Scissor Hasp c/w Cable |   |
|                   |   |                                       |   |   |  |  |   |
|                   |   |                                       |   |   |  |  |   |

**Sample Configurations**



**ATA1STOP024 CLIS**

A tongue operated access lock with control switch to safeguard a hatch. Access is only possible after isolation of the machine power, where the access key is released after the machine is switched off.



**SBILOK024024IR**

A solenoid controlled safety switch with internal release function and a sidebar operated actuator for effective access.

The high ingress protection class (IP67) makes amGard most suitable for any outdoor use (when mounted correctly).



|   |   |   |  |  |  |   |  |
|---|---|---|--|--|--|---|--|
| <b>Head Modules</b><br><b>Adaptors</b><br><b>Electrical Switching / Locking</b><br><b>Option PODs</b> | <b>Cap</b><br><br><b>CP</b>                        | <b>Handle Actuator &amp; Head</b><br><br><b>AM</b>   | <b>AM Lock-Out Clip</b><br><br><b>AML</b>  | <b>Tongue Actuator &amp; Head</b><br><br><b>AT</b>  | <b>AT Lock-Out Clip</b><br><br><b>ATL</b>         | <b>Slidebar</b><br><br><b>SBN</b> No Spring & no Internal Release<br><b>SBS</b> Spring Loaded<br><b>SBI</b> Internal Release |  |
|   | <b>Safety Key Adaptor</b><br><br><b>S1 S1 » S5</b> | <b>Access Key Adaptor</b><br><br><b>A1 A1 » A5</b>   | <b>Single Lock-Out Padlock Adaptor</b><br><br><b>LO</b>  | <b>Dual Lock-Out Padlock Adaptor</b><br><br><b>LT</b>   | <b>Internal Release Adaptor</b><br><br><b>IRA</b> | <b>Foot</b><br><br><b>FOOT</b>   |  |
|   | <b>Safety Switch Body</b><br><br><b>STOP</b>       | <b>Solenoid Controlled Switch Body</b><br><br><b>LOK</b> Power to Unlock<br><b>LOKPL</b> Power to Lock | <br><b>LOKIR</b> Internal Release & Power to Unlock<br><b>LOKPLIR</b> Internal Release & Power to Lock | <b>Explosion Protected Safety Switch Body</b><br><br><b>STOPXP</b> UL/CSA certified<br><b>STOPTX</b> ATEX certified |  |   |  |
|   | <b>Key Switch Pod</b><br><br><b>PODK</b>         | <b>Pushbuttons Pod</b><br><br><b>PODB</b>  | <b>Indicator Lamps Pod</b><br><br><b>PODL</b>  |  |  |   |  |
|   | <p><b>AS available</b></p>  |   |  |  |  |   |  |

**eGard** is the new totally modular approach to controlling access to hazardous machinery and equipment. A compact access and control system has been developed that enables a selection of configurations including mechanical trapped key interlocks, electrical safety gate switch interlocks and electrical operator controls, either as separate devices or intergrated into one device.

The system features patented mechanical and electrical connections between every module. It simply clips together and the internal network is self-configuring. With over 4,000 billion possible combinations of modules it can be easily customised for every access and control application. The **eGard** product range is defined into three sections: head modules, core modules and base modules.

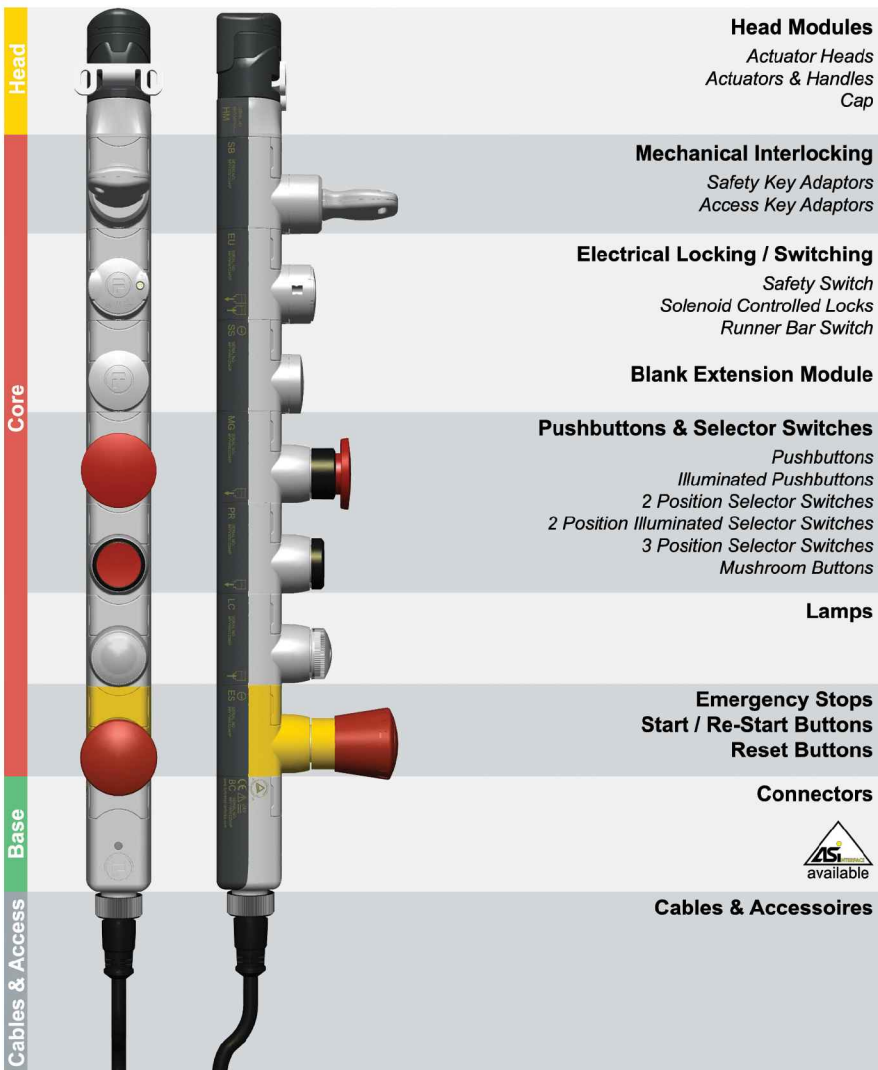

**Module Configuration & Assembly:**

A module stack consists of a head module (actuator head or cap), at least one core module (switches, buttons or lamps) and a base module for data-transfer to the PLC-control. Base modules are also available for AS-interface fieldbus systems. Maximum number of modules = 11 (including head and base).

**Mounting Principle:**

This mechanical and electrical combinable eGard closure-system configured, for PLC-systems, consists of connectable modules with different functions and can be used on hinged and sliding doors or just as a control configuration. The stacks can be mounted directly onto a flat surface, doors or extruded profiles, without the need for mounting plates or brackets.

**Configuration and Wiring Setup:**

The wiring is configuration specific. The eGard range incorporates safety circuits and standard I/O (input / output) in a single product. The safety and control circuits are separate through all of the modules and are terminated in the head module. The control circuits form an internal network.

**Base connector selection:**

There is a selection of different base modules, that enable the connection of just the safety circuits (4-pole) or both, safety and control circuits (14-pole) up to 8 I/O. Alternatively a 4-pole ASi-connector can be used for bus-systems (max. 4 I and 4 O). eGard configurations are suitable for use in up to SIL3 (EN/IEC 62061), Category 4 and PLe (EN/ISO 13849-1).

**Connection:**

Depending on the type and amount of core modules 4- or 14-pin ready made cables can easily be connected to the base module.

**Material and Surface Versions:**

Module housings made of plastic PBT and 304 stainless steel internals. Upper part light grey coloured, lower part dark grey coloured.

**Protection Class:**

The protection class conforms to IP65 when correctly mounted.

- Locking, switching and machine controls in one configuration with one Pre-wired connector
- From conventional I/O to AS-i bus by just changing the base module
- Simple to add modules to existing configurations
- All eGard mechanically tested to 1 million operations
- Type tested and approved by TÜV Rheinland Group
- All electrical eGard modules are CE-marked



**eGard Application Examples**

eGard offers the possibility to configure solutions to safeguard, regulate access and control of machinery and/or guarded areas, as is shown in the automated production line example, below.

- 1 HMSBEUSSP4LCBC-AH**  
Handle operated door lock with a safety key, a solenoid controlled safety switch, an access request button and an indication lamp (for full body access doors).
- 2 HCSNSSBS**  
The safety key from configuration 1 can be inserted in the key switch module to activate a teach mode function.
- 3 H MSSBS-AH**  
Handle operated door lock with safety switch, that terminates the machine after opening the door (for part body access doors).
- 4 HCEMBB**  
A monitored emergency stop.

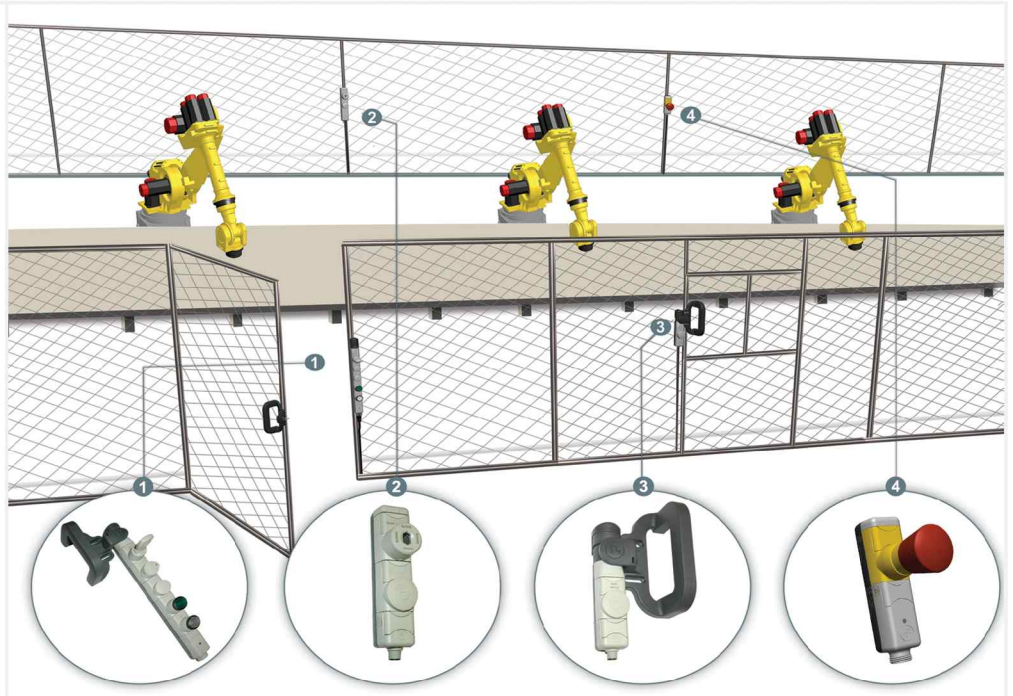

**Trapped Key Interlocking Principles**

A simple mechanical system of interlocking, without need for wiring to the access gates, keys are trapped and freed in a defined logic sequence, for machine controls, as well as allowing access when the guarded area or machine is safe to enter.

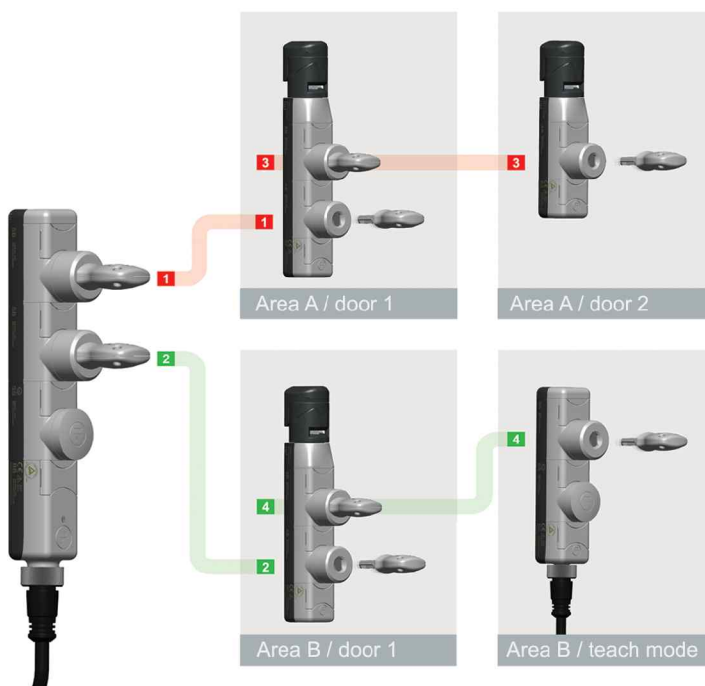

By turning key 1 or 2 in the key controlled switch configuration, the dual safety circuits are broken and the machine stopped.

**Key 1** can be used to open door 1 of the safeguarded area A.

**Key 2** can be used to open door 1 of the safeguarded area B.

**Key 3** is a safety key that keeps key 1 trapped in the door lock preventing machine restart and can also be used to open a door inside area A.

**Key 4** is a safety key that prevents machine restart and can also be used to start machine teachmode inside area B. using a key controlled switch configuration.

**Trapped Key Interlock Interfacing**

Interfacing trapped key interlocks with safety gate switch and/or control functions does offer unique and new methods to improve, optimise, and rationalise the implementation of all these safety related functions into one system.



**General Guidelines**

- A configuration must be made up of one head module, at least one core module and one base module
- Configuration sequence is: head module, safety locks, access locks, solenoid, safety switches, control modules and base.
- Maximum number of modules = 11 (including head & base)

**Head Modules**

- HF** incl. fixed actuator
- HM** head only



**Actuator Head**

For gate switch and door lock configurations.

- Rotatable through 360 degrees
- Top and side entry
- Operating force 5 to 10N
- Retention force 1000N

- HC**



**Cap**

Used to terminate all non door lock or gate switch configurations.

- Used in mechanical exchange box, machine control or key switch configurations.

**Actuators**

- AF** fixed actuator
- AG** actuator used in handles



**Fixed Actuator**

- Fixed actuator suitable for mounting for either sliding or hinged doors.

*Must be used in combination with a HM head module.*

- AH** hinged door actuator
- AS** sliding door actuator



**Handle Actuators**

- Handle actuators suitable for bracketless mounting for either sliding or hinged doors.

*Must be used in combination with a HM head module.*

Handles for hinged and sliding doors:

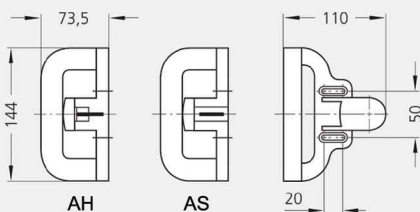

AH



AS

**Mechanical Interlocking**

Mechanical lock modules - for use in trapped key configurations (e.g. key switches, exchange boxes and door locks). It can also be used in conjunction with safety gate switches to add further levels of access control (e.g. modular safety keys to prevent accidental lock in of personnel in full body access applications or additional key transfer).

**Access Key Module**

- AB** standard lock
- QB** master lock



For access (premission) functions.

- Robust radial disc tumbler lock
- >3000 combinations
- 10 mastered combinations (can be used with all 3000 individual combinations)
- No key included
- Max No of mechanical locks = 6

**Safety Key Module**

- SB** standard lock
- GB** master lock



To prevent accidental lock in of personnel.

- Robust radial disc tumbler lock
- >3000 combinations
- 10 mastered combinations (can be used with all 3000 individual combinations)
- Key included
- Max No of mechanical locks = 6

**Keys**

- KS** standard key
- KM** master key



Master key can only be used in combination with masterable lock modules.

**Electrical Locking / Switching**

eGard offers four different electrical locking/switching modules. The safety switch module, is driven by either the operation of the head module (removal of actuator or handle) or a mechanical lock. The module is for instance used to switch "off" an installation when opening the door. The solenoid controlled lock is also able to lock a door or trap a key until the area is safe to enter. The runner bar switch only detects the operation of the head module or mechanical lock and translates this into a I/O signal.

**Safety Switch**

**SS**



Can be driven by either the operation of the head module (removal of actuator) or a mechanical lock.

- Operates on dual safety circuits
- 2 force break positive by guided NC safety contacts
- Uses none of the I/O pins



**Solenoid Controlled Lock**

- EU** power to unlock
- EL** power to lock



To electrically lock a door or trap a mechanical key. This module restricts access until it is safe.

- Both have a single sensor to monitor when the module is locked
- Uses 1 output and 1 input pin
- A high output indicates that the solenoid has successfully locked the runnerbar by energising the solenoid



RB



**Runner Bar Switch**

Runner bar monitoring switch available. Can be driven by either the runner bar operation of the head module (removal of actuator) or a mechanical lock.

- 1 output indicating the runner bar position (each runner bar status module uses 1 output pin)



**Extension Blank Modules**

EB



**Blank Extension Module**

Additional blank module for extending a configuration.

*Generally used for spacing between core modules.*

**Pushbutton Modules**

- PG** green   **PY** yellow
- PR** red
- PW** white
- PB** black
- PZ** blue



**Pushbuttons - Flat**

- Uses 1 output pin
- Output goes high when pushbutton is pressed

*Other colours are available on request.*



- P1** red   **P7** white
- P2** yellow
- P3** green
- P4** clear
- P6** blue



**Pushbuttons - Flat Illuminated**

- Uses 1 output pin and 1 input pin
- Output goes high when pushbutton is pressed
- Lamp illuminates when input is high

*Other colours are available on request.*



- M1** **MB** black
  - M2** **MR** red
  - M3** **MY** yellow
  - MG** green
- non-latching  
latching



**Pushbuttons - 40mm Mushroom**

- Uses 1 output pin
- Output goes high when pushbutton is pressed
- Non-latching - spring return to original position
- Latching - stay in each switch position

*Other colours are available on request.  
Red mushroom buttons cannot be used in the USA.*



eGard simply clips together and provides a vast number of options. Modules such as stop and start switches and indicator lights can be included in the one unit, with or without gate switch modules. This eliminates much of the wiring and connection time involved with control panels. Ease of installation also provides a huge cost saving for specifiers.





**Selector Switches**

- 2A 2D** black
  - 2B 2E** red
  - 2C 2F** green
  - 2G 2H** white
- non-latching  
latching



**2 Position Selector Switches**

- Output goes high when selector switch is turned
- Each 2 position selector switch uses 1 output pin
- Non-latching - spring return to original position
- Latching - stay in each switch position



*Other colours are available on request.*

- 3A 3D** black
  - 3B 3E** red
  - 3C 3F** green
  - 3G 3H** white
- non-latching  
latching



**3 Position Selector Switches**

- Output goes high when selector switch is turned
- Each 3 position selector switch uses 2 output pins
- Non-latching - spring return to original position
- Latching - stay in each switch position



*Other colours are available on request.*

- 2J 2N** red
  - 2K 2O** green
  - 2L 2P** white
- non-latching  
latching



**2 Position Illuminated Selector Switches**

- Output goes high when selector switch is turned
- Each 2 position illuminated selector switch uses 1 input pin and 1 output pin
- Non-latching - spring return to original position
- Latching - stay in each switch position



*Other colours are available on request.*

- K1** 2 position
- K2** 3 position



**Ronis Key Switch**

- 2 position switch uses 1 output pin
- 3 position switch uses 2 output pins
- Including Ronis key
- Latching - stay in each switch position

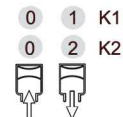

K1 : Siemens 3SB30 00-4AD01  
K2 : Siemens 3SB30 00-4DD01

- K3** 2 position
- K4** 3 position



**BKS ET Key Switch**

- 2 position switch uses 1 output pin
- 3 position switch uses 2 output pins
- Excluding BKS ET key
- Latching - stay in each switch position

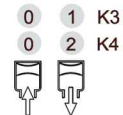

K3 : Siemens 3SB30 00-5AE31 (E2 : Volkswagen)  
K4 : Siemens 3SB30 00-5AE51 (E7 : Volkswagen)

**Lamps**

- LB** blue **LY** yellow
- LC** clear
- LG** green
- LR** red
- LW** white

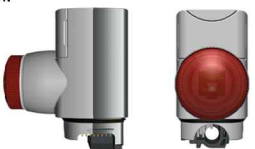

**LED Lamps**

- LED status indicator
- Each lamp uses 1 input pin



*Other colours are available on request.*

**Emergency Stops / Start Re-Start**

- EM ES 40mm
  - ED EC 30mm
- no monitoring  
monitoring

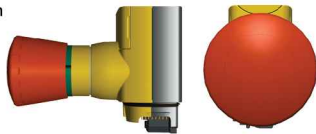

**Twist Release Emergency Stop**

- 2 force break NC Safety contacts (uses none of the I/O pins for safety function)
- Monitored version (EM) also has 1 monitoring contact and thus uses 1 output pin
- 30mm or 40mm button

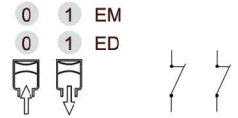

*Standard twist release operates on dual safety contacts.*

- EK no monitoring
- EJ monitoring

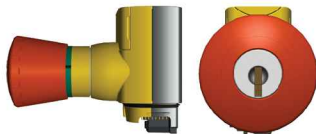

**Emergency Stop with Key Operated Reset**

- 2 force break positive make NC Safety contacts (uses none of the I/O pins)
- Monitored version (EK) also has 1NO monitoring contact, uses 1 output pin
- With Ronis key operated reset function
- 40mm button



*Twist release after use of the reset key.*

- SC



**Start Re-start Key Switch**

- Start restart key switch, operating on safety circuits
- Uses 1 NO and 1 NC
- For safety relay re-set
- With Ronis key operated reset function
- Latching - stay in each switch position



*Cannot be used in combination with any other module that acts on the safety circuits.*

- SR blue
- ST black
- SX red
- SY white
- SZ yellow



**Start Re-start**

- Start restart pushbutton, operating on safety circuits
- Uses 1 NO and 1 NC
- For safety relay re-set



*Cannot be used in combination with any other module that acts on the safety circuits.*

**Connectors**

- BF



**Foot**

For terminating mechanical configurations (no wiring).

- BS



**Safety Only Connector**

4 pin M12 for connecting dual safety circuits (uses none of the I/O)

Safety & Control Connectors

- BB 2 I/O sourcing output
- BC 8 I/O sourcing output
- BD 2 I/O sinking output
- BE 8 I/O sinking output



- All versions connect dual safety circuits and either up to 2 inputs/outputs or up to 8 inputs/outputs
- 14 pin connector
- 24 Vdc supply

AS-Interface Connectors

- BA AS-I safety & control
- BG AS-I control only
- BH AS-I safety only



- BA 4 pin M12 base for connecting dual safety circuits and up to 4 inputs and up to 4 outputs.
- BG 4 pin M12 base for connecting controls only up to 4 inputs and up to 4 outputs (uses one address).
- BH 4 pin M12 base for connecting dual safety circuits only (uses one address).

Cables & Accessories

4 Pin Cables

- 24 2m
- 54 5m
- 14 10m
- 04 20m



- Single ended straight connector an cable
- 4 pin M12

14 Pin Cables

- 21 2m
- 51 5m
- 10 10m
- 20 20m



- Single ended straight connector
- 14 pin

Marked Legend Plates

- VG landscape grey
- VY landscape yellow
- HG portrait grey
- HY portrait yellow
- DG image grey
- DG image yellow



- Grey (or yellow for emergency stop modules)
- For vertically mounted configuration (landscape legend plate) up to 3 lines of 17 digits long and 3mm high
- For horizontally mounted configuration (portrait legend plate) up to 2 lines of 11 digits long and 3mm high
- Both portrait and landscape legend plates are also available with an image (DWG format)



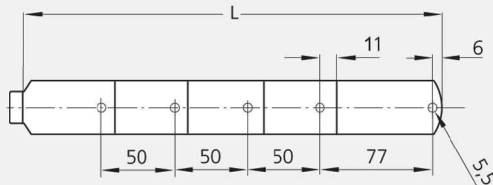

HC head module has no mounting holes

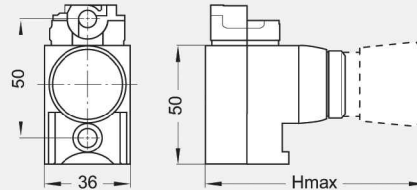

| Designation           | Hmax (mm) |
|-----------------------|-----------|
| Key Modules           | 100       |
| Solenoid Locks        | 55        |
| Safety Switch         | 48        |
| Runner Bar            | 48        |
| Emergency Stops       | 100       |
| Ronis/BKS Key modules | 96        |
| Pushbuttons           | 59        |
| Mushroom Buttons      | 76        |
| Selector Switches     | 76        |
| Lamps                 | 63        |
| Connectors/Heads      | 35        |

**Assembly & Mounting of Modules \***

1. The upper module will be connected to the lower module by simply clicking together.
2. Inserting the joining tube through the middle bore secures the module connection.
3. After connecting all modules according to step 2 the configuration can be mounted e.g. on a grooved profile by slot nuts and cap head screws M5. (or alternatively bolting on flat surface)
4. Finally the cover caps will be pushed on the connecting bores of the module housings.

- \* To assure IP 65, all modules must be fixed.
- \* All fixings must be used and tightened to the torque setting specified in the installation instructions.
- \* Complete ordered configurations are supplied fully assembled.

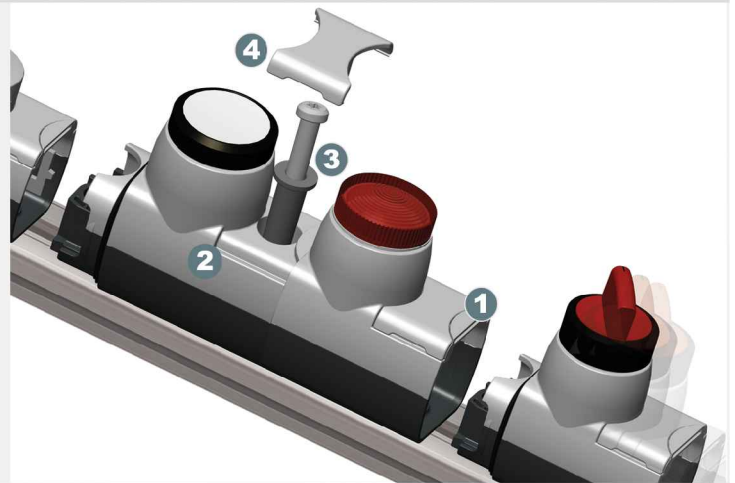

**Configuration Rules**

1. A configuration must be made up of one head module, at least one core module and one base module.
2. Maximum No of modules = 11 (including head & base).
3. Configuration sequence is: head module, safety locks, access locks, solenoid, safety switches, control modules and base.
4. The start / restart (SR, ST, SW, SX, SY & SZ) module cannot be used in stacks with another module that works on the safety circuits.
5. All eGard configurations are suitable for use in Installation Category 4 (to EN954-1) applications apart from ones combining an e-stop and a gate switch having an ES and SS in same stack (this is Installation Category 3 to EN954-1).

**Electrical Guidelines**

Control modules with inputs/outputs (I/O) can be configured in any order in the stack (the internal eGard network is self configuring). Table 1 shows how many I/O connections can be made using the different types of connector, and table 2 shows each core modules I/O requirements.

| Ref N° | Description                 | Max I/O     | Connects safety circuits |
|--------|-----------------------------|-------------|--------------------------|
| BS     | Safety Only                 | Zero        | Yes                      |
| BB     | Safety and Control sourcing | Max 2 I/O   | Yes                      |
| BC     | Safety and Control sourcing | Max 8 I/O   | Yes                      |
| BD     | Safety and Control sinking  | Max 2 I/O   | Yes                      |
| BE     | Safety and Control sinking  | Max 8 I/O   | Yes                      |
| BA     | Safety and Control AS-I     | Max 4I & 4O | Yes                      |
| BH     | Safety Only AS-I            | Zero        | Yes                      |
| BG     | Control Only AS-I           | Max 4I & 4O | No                       |

Table 1: max I/O connections per base connector type

| I/O relative to eGard                  |                        | inputs (I) | outputs (O) | connects to safety circuits |
|--|------------------------|------------|-------------|-----------------------------|
| Head Modules                           | HF, HM, HC             | 0          | 0           | -                           |
| Mechanical Interlocking                | AB, SB                 | 0          | 0           | -                           |
| Safety Switches                        | SS                     | 0          | 0           | Yes                         |
| Solenoid Controlled Locks              | EU, EL                 | 1          | 1           | -                           |
| Runner Bar Modules                     | RB                     | 0          | 1           | -                           |
| Blank Extension Modules                | EB                     | 0          | 0           | -                           |
| Pushbuttons Flat                       | PB, PG, PR, PW, PZ, PY | 0          | 1           | -                           |
| Pushbuttons Flat Illuminated           | P1 - P7                | 1          | 1           | -                           |
| 2 Position Selector Switches           | 2A - 2H                | 0          | 1           | -                           |
| 3 Position Selector Switches           | 3A - 3H                | 0          | 2           | -                           |
| 2 Position Illuminated Selector Switch | 2J, 2K, 2L, 2N, 2O, 2P | 1          | 1           | -                           |
| 2 Position Key Switch                  | K1, K3                 | 0          | 1           | -                           |
| 3 Position Key Switch                  | K2, K4                 | 0          | 2           | -                           |
| Pushbutton 40mm Mushroom               | M1, M2, MB, MR, MG     | 0          | 1           | -                           |
| Lamps                                  | LR, LG, LC, LB, LW, LY | 1          | 0           | -                           |
| Emergency Stop                         | ES, EC                 | 0          | 0           | Yes                         |
| Monitored Emergency Stop               | EM, ED                 | 0          | 1           | Yes                         |
| Key Operated E-stop                    | EK                     | 0          | 0           | Yes                         |
| Monitored Key Operated E-stop          | EJ                     | 0          | 1           | Yes                         |
| Start / Re-start Buttons               | SR, ST, SW, SX, SY, SZ | 0          | 0           | Yes                         |
| Key Operated Start / Re-start Buttons  | SC                     | 0          | 0           | Yes                         |

**Designation**

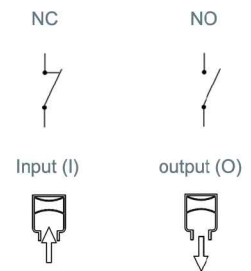

Table 2: Core module I/O requirements

**Technical Information**

| Base Modules      | Max. current      |
|-------------------|-------------------|
| 4 pole            | 200 mA            |
| 14 pole           | 200 mA            |
| 4 pole AS-i       | 75 mA             |
| Temperature Range | -5... + 40 C°     |
| Operating Voltage | 24V DC (Not AS-I) |

Max. Relative Humidity 93(+/-3)% without any dew on the device

Ingress Protection IP65

**Creating a Part Number**

An eGard configuration part number can simply be created by adding up the single used module part numbers in sequence from head to base. The legend plates, cables, and door actuators must be ordered separately and are not part of the configuration part number. Below an example of how to create an eGard part number:

The complete part number of the example configuration is: HFSBELSSPGPWC - 51

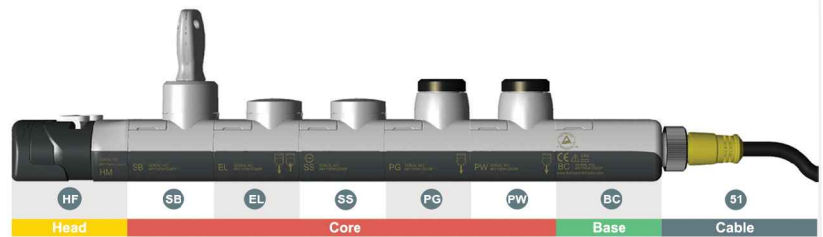

**Wiring Schemes**

By using the eGard configurator ([www.fortressinterlocks.com](http://www.fortressinterlocks.com)) you are able to simply extract a wiring diagram of each configuration. You can also contact our Technical Sales department for any assistance. Shown below is a wiring diagram for both the 14 pin (safety & control) and the 4 pin (safety only and AS-I) connector.

| I/O Assigned from base upwards | Wire Colours | Connector Pins |
|--------------------------------|--------------|----------------|
| +24 V                          | Brown        | 4              |
| 0 V                            | Blue         | 6              |
| Safety circuit 1               | White        | 10             |
| Safety circuit 1               | Grey         | 13             |
| Safety circuit 2               | Brown/Yellow | 5              |
| Safety circuit 2               | Brown/Green  | 12             |
| I/O 0                          | Red/Blue     | 11             |
| I/O 1                          | White/Yellow | 3              |
| I/O 2                          | White/Green  | 2              |
| I/O 3                          | Grey/Pink    | 1              |
| I/O 4                          | Pink         | 9              |
| I/O 5                          | Green        | 8              |
| I/O 6                          | Yellow       | 7              |
| I/O 7                          | Red          | 14             |

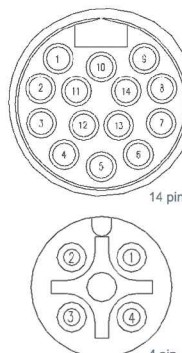

| I/O Assigned from base upwards | Wire Colours | Connector Pins |
|--------------------------------|--------------|----------------|
| Safety circuit 1               | Brown        | 1              |
| Safety circuit 2               | White        | 2              |
| Safety circuit 1               | Blue         | 3              |
| Safety circuit 2               | Black        | 4              |

Table 4: BS 4 Pin Control only Connectors wiring scheme

| Pins | Description |
|------|-------------|
| 1    | AS-I +      |
| 2    | -           |
| 3    | AS-I -      |
| 4    | -           |

Table 5: 4 Pin AS-i connector wiring scheme

Table 3: BC 14 Pin Control & Safety Connector wiring scheme

Head

**Head/Cap**

Ref N°

- HF Head incl. Fixed Actuator
- HM Head Only
- HC Cap

**Handles & Actuators**

- AF Fixed Actuator
- AG Actuator used in Handles
- AH Hinged Door Handle
- AS Sliding Door Handle

Core

**Mechanical Interlocking**

Ref N°

- AB Standard Lock
- QB Master Lock
- SB Standard Lock
- GB Master Lock
- KS Standard Key
- KM Master Key

**Electrical Locking/Switching**

- Solenoid Controlled Lock
- EU Power to Unlock
- EL Power to Lock
- SS Safety Switch
- RB Runner Bar Switch

**Extension Blank Module**

- EB Extension Blank Module

**Pushbuttons**

Ref N°

**Flat**

- PG green
- PY yellow
- PR red
- PB black
- PW white
- PZ blue

**Flat Illuminated**

- P1 red
- P2 yellow
- P3 green
- P4 clear
- P6 blue
- P7 white

**40mm Mushroom Latching**

- M1 black
- M2 red
- M3 yellow

**40mm Mushroom Non-Latching**

- MB black
- MR red
- MY yellow
- MG green

**Lamps**

- LB blue
- LR red
- LC clear
- LW white
- LG green
- LY yellow

**Start / Re-Start**

- SC Start/Re-Start Key Switch
- SR Start / Re-Start for Safety Relay Reset (blue)
- ST Start / Re-Start for Safety Relay Reset (black)
- SX Start / Re-Start for Safety Relay Reset (red)
- SY Start / Re-Start for Safety Relay Reset (white)
- SZ Start / Re-Start for Safety Relay Reset (yellow)

**Selector Switches**

Ref N°

**2 Position Latching**

- 2A black
- 2B red
- 2C green
- 2G white

**2 Position Non-Latching**

- 2D black
- 2E red
- 2F green
- 2H white

**3 Position Latching**

- 3A black
- 3B red
- 3C green
- 3G white

**3 Position Non-Latching**

- 3D black
- 3E red
- 3F green
- 3H white

**2 Position Illuminated Latching**

- 2J red
- 2K green
- 2L white

**2 Position Illuminated Non-latching**

- 2N red
- 2O green
- 2P white

**Selector Switches**

part n°

- Ronis Key Switch Latching
  - K1 2 Position
  - K2 3 Position
- BKS ET Key Switch Latching (E2, ET Volkswagen)
  - K3 2 Position (E2)
  - K4 3 Position (E7)

**Emergency Stops**

- Twist-Release 40mm Emergency Stop
  - EM Monitoring
  - ES No Monitoring
- Twist-Release 30mm Emergency Stop
  - ED Monitoring
  - EC No Monitoring
- E-stop with Ronis Key Operated Reset
  - EJ Monitoring
  - EK No Monitoring

Base

**Connectors**

Ref N°

- BF Foot
- BS Safety Only Connector
- Safety & Control Connector 14 pin
  - BB 2 I/O Sourcing Output
  - BC 8 I/O Sourcing Output
- Safety & Control Connector 14 pin
  - BD 2 I/O Sinking Output
  - BE 8 I/O Sinking Output
- AS-I Connector 4 pin
  - BA AS-I Control & Safety (4I & 4O)
  - BG AS-I Control Only (4I & 4O)
  - BH AS-I Safety Only

Cables & Access

**Cables**

Ref N°

- 4 pin M12
  - 24 2m
  - 14 10m
  - 54 5m
  - 04 20m
- 14 pin
  - 21 2m
  - 10 10m
  - 51 5m
  - 20 20m

**Marked Legend Plates**

- E-STOP
- VG Landscape Grey
- VY Landscape Yellow
- ACCESS
- REQUEST
- HG Potrait Grey
- HY Potrait Yellow
- DG Image Grey
- DY Image Yellow





A HALMA COMPANY



Official Distributor

**Fortress Interlocks Ltd**

☎ +44 (0)1902 349000  
☎ +44 (0)1902 349090  
✉ sales@fortressinterlocks.com

**Fortress Interlocks Europe**

☎ +31 (0)10 7536060  
☎ +31 (0)10 7536050  
✉ europe@fortressinterlocks.com

**Fortress Interlocks USA**

☎ +1 (859) 578 2390  
☎ +1 (859) 341 2302  
✉ us@fortressinterlocks.com

**Fortress Systems Pty Ltd**

☎ +61 (0)3 9587 4099  
☎ +61 (0)3 9587 4130  
✉ australia@fortressinterlocks.com