



PRODUCTS

Design and Operation

In all BOLLFILTERs Automatic, wedge wire or wire mesh candles are cleaned automatically by backflushing without interrupting operation. This can be actuated either by differential pressure or is time controlled. Automatic filters are used for applications with continuous contamination and for which manual cleaning is uneconomical, or if the sites and processes are automated.

BOLLFILTER Automatic
Type 6.18

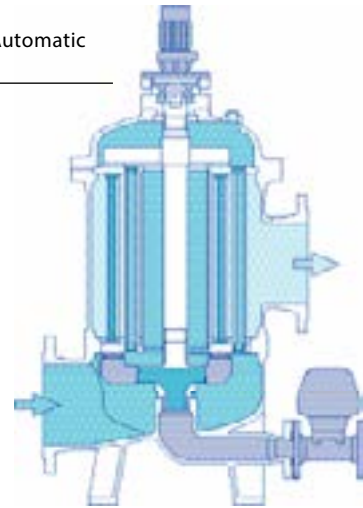

The main field of application for this BOLLFILTER Automatic is water filtration. The internal components are therefore always made of stainless steel. The fully automatic backflushing of the filter element is very efficient. Axial- and cross-flow backflushing is generated with filter candles open at both ends – the bipolar functional principle.

Application

Filtration of



oil



fuel



water



coolant



chemicals,
alkalines

Installed in the pressure or suction line to protect the downstream plant components from contamination.

Advantages

- large filter surfaces, long service times
- precisely defined grades of filtration
- systematic removal of filtered particles
- precise backflushing device
- low flushing quantities
- backflushing without interrupting operation
- low pressure losses
- low maintenance
- low operating costs
- long life time
- compact, space-saving design

Filter types

BOLLFILTER Automatic Type 6.18/6.19



Version with external
medium connection
for low operating
pressures
(Type 6.19
DN 50-DN 400)



Nominal diameters

DN 50 - DN 1000 / 2" - 40"

Backflushing

actuated by differential pressure
or time control

Material variations

nodular cast iron, carbon steel, c.s. rubber lined, stainless steel, special alloys

Filter housing

Pressure stages

PN 10*

Grades of filtration**

30 µm – 5000 µm

* dependent on the filter size,
higher pressure stages available on request

** dependent on the filter size

Design and Operation

BOLLFILTER Auton
Type 6.18.2 Heavy

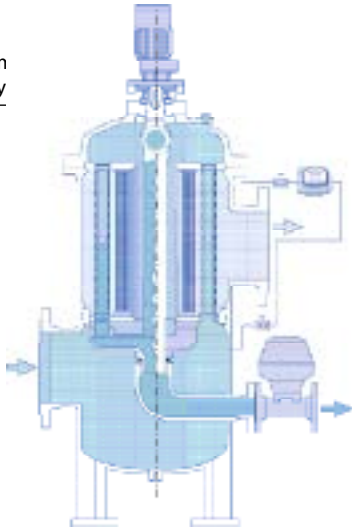

On the BOLLFILTER Automatic Type 6.18.2, rotating flushing arms are located above and below the filter element. The re-designed filter candles are backflushed alternately from above and below within one cleaning cycle, without interrupting of filtration and by using the internal medium. The hydrodynamic element, which is positioned in the centre of the filter candle, increases the flow velocity in addition and thus optimises the effectiveness of the backflushing process. This filter type is suitable for difficult operating conditions, e.g. for the filtration of river water, lake water or sea water.

BOLLFILTER Auton
Type 6.18.3C

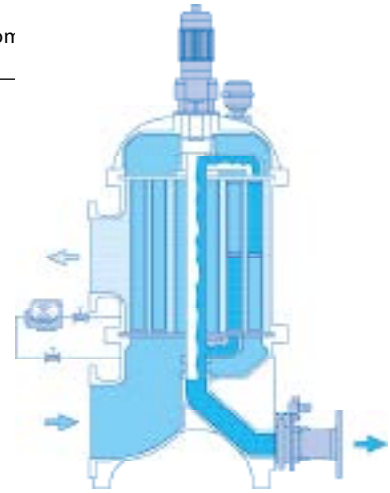

The BOLLFILTER Automatic Type 6.18.3C presents an ideal solution for the filtration of ballast water. The small footprint makes it suitable for retrofits and new buildings. Furthermore, the filter is extremely durable and easy to maintain. The filter element with precision filter candles open at both ends is giving a dual backflushing effect. This design of the filter elements generates cross-flow turbulence in the backflush process which is further enhanced by the Hydrodynamic Element. The regeneration is very quick and effective without interrupting the filtration process.

BOLLFILTER Automatic Type 6.18.2 Heavy Duty



BOLLFILTER Automatic Type 6.18.3C



Nominal diameters	DN 50 - DN 1000 / 2" - 40"
Backflushing	actuated by differential pressure or time control
Material variations Filter housing	carbon steel, c.s. rubber lined, stainless steel, special alloys
Pressure stages	PN 6 / PN 10*
Grades of filtration**	50 µm – 5000 µm

Nominal diameters	DN 200 – DN 900
Backflushing	actuated by differential pressure
Material variations Filter housing	up to DN 400 nodular cast iron from DN 500 C-carbon steel
Pressure stages	up to DN 600 PN 10 / from DN 700 PN 6
Grades of filtration**	optional 30 µm, 40 µm or 50 µm

* dependent on the filter size,
higher pressure stages
available on request

** dependent on the filter size

BOLLFILTER Autom.
Type 6.46

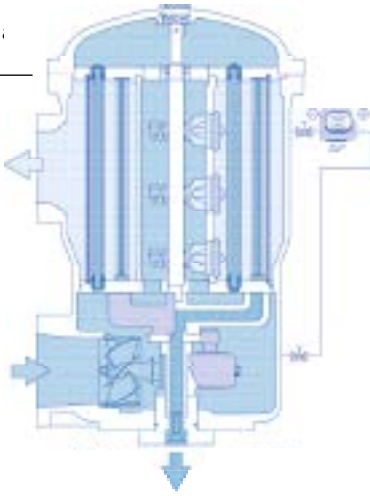

This compact filter, for horizontal or vertical installation, is used primarily in lubricating oil systems. Its turbine-driven, continuously rotating flushing mechanism works almost without wear, even with low quantities and pressure levels. The fine filter candles are resistant to differential pressure up to full operating pressure level. The continuous axial- and cross-flow backflushing system allows cleaning over the entire length of the candle. A safety element and over-flow valves in the first section of the filter provide safety in case of emergency.

BOLLFILT
Type 6.2

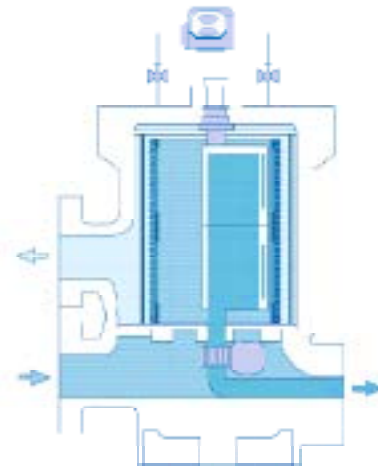

The BOLLFILTER Automatic Type 6.21 has been especially designed for the filtration of lower and continuous filtration volumes of liquid fuels. The filter operates predominantly for the protection of diesel injection pumps. When required, the media is cleaned one segment at a time by a rotating back-flush unit, without interrupting the filtration process. The working pressure remains almost constant and the flushing volumes are extremely low. The filter can optionally be equipped with a heating medium connection on the bottom of the housing and with a bypass filter.

BOLLFILTER Automatic Type 6.46



DN 50 – DN 150

continuous

nodular cast iron

PN 10

25 µm – 34 µm

BOLLFILTER Automatic Type 6.21/6.22

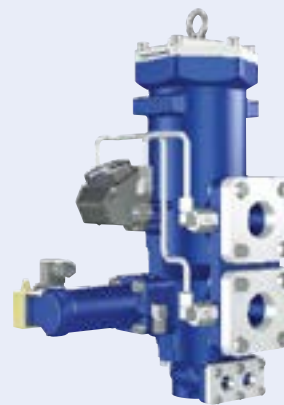

Version with
Bypass-filter
(Type 6.22.1)



DN 50 (optional with adapter to DN 32)

actuated by differential pressure

nodular cast iron

PN 16

optional 10 µm, 25 µm, 34 µm oder 48 µm

BOLLFILTER Automatic
Type 6.72

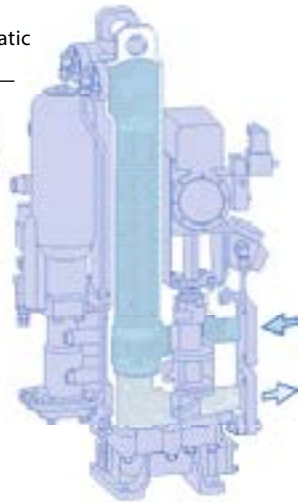

The BOLLFILTER Automatic Type 6.72 was specially developed for smaller flow rates of fuels and lubricating oils. Its special design allows filtration grades up to 6 µm. A bypass filter with change-over valve can be integrated to use Type 6.72 as a fuel filter.

BOLLFILTER Automatic
Type 6.64

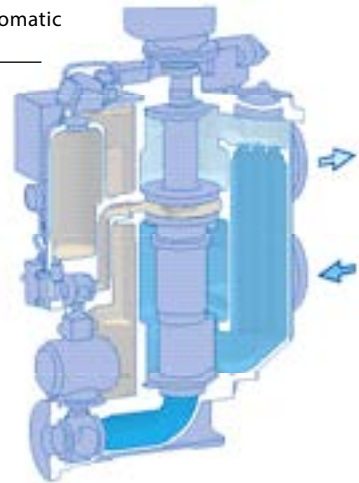

The automatic high-performance filter Type 6.64 is used mainly for the filtration of large volumes of fuels, lubricants, coolants and alkalines. In a compact housing with its several filter chambers, filtration and backflushing operate simultaneously and independently without interrupting the process. The filter candles are regenerated extremely quickly and efficiently by supporting backflushing with compressed air. This ensures only small volumes of flushing liquid are used. The system pressure remains constant during the backflushing process.

BOLLFILTER Automatic Type 6.72



Version with
bypass-filter
(Type 6.72.1)



DN 40 – DN 80

actuated by differential pressure
or time control

nodular cast iron

PN 16

6 µm – 200 µm

BOLLFILTER Automatic Type 6.64



Version with treat-
ment unit for the
flushing liquid
(Type 6.64.07)



DN 100 – DN 400

actuated by differential pressure
or time control

nodular cast iron,
nodular cast iron nickle plated

PN 16**

6 µm – 200 µm

Design and Operation

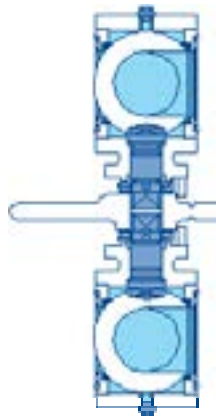
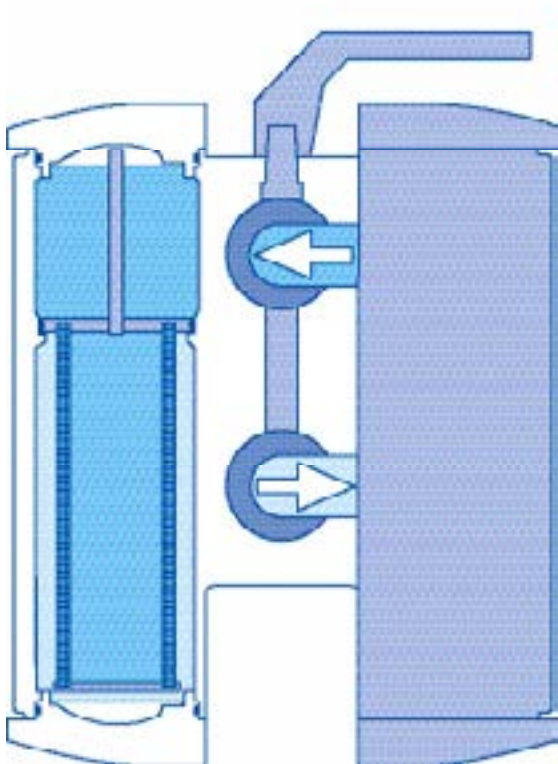

Three-way ball valve



Change-over cock

Filter types

BOLLFILTER Duplex Type 2.04.5



BOLLFILTER Duplex Type 2.05.5

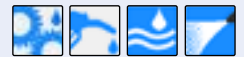

Nominal diameters

Switch-over

Material variations

Filter housing

Pressure stages

Grades of filtration

DN 25 – DN 80

change-over cock

nodular cast iron

PN 25*

10 µm – 5000 µm

DN 100 – DN 250

change-over cock

cast iron, nodular cast iron,
cast iron rubber lined

PN 10

10 µm – 5000 µm

* dependent on the filter size

Please contact us for detailed information
+49 2273 562-0 or info@bollfilter.com

Application

Duplex filters comprise two filter housings. One chamber of the filter is on duty whilst the other clean half is on stand-by. When the contamination level exceeds a preset tolerance level, the flow can be switched manually to the cleaned half of the filter without any pressure shock. The contaminated filter element is cleaned whilst the process continues. Change-over is performed by a cylindrical cock valve or double stage three-way ball valves. The design prevents both filter chambers from being shut off at the same time.

Filtration of



Installed in the pump pressure or suction line to protect the downstream process components from contamination.

Advantages

- large filtration surfaces
- long service life
- low pressure losses
- precisely defined degrees of filtration
- long life time
- simple handling
- switch-over without pressure shock
- compact, space-saving design



DN 25 – DN 150
 ball valve
 nodular cast iron
 cast steel, cast stainless steel
 PN 16 / PN 40*
 0,5 µm – 5000 µm

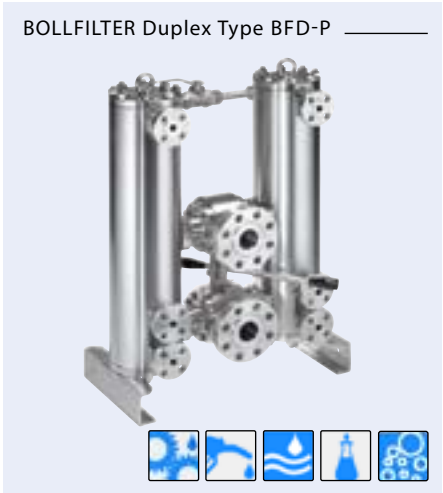

DN 25 – DN 200
 ball valve
 carbon steel, stainless steel;
 non-welded
 max. PN 100
 0,1 µm – 250 µm

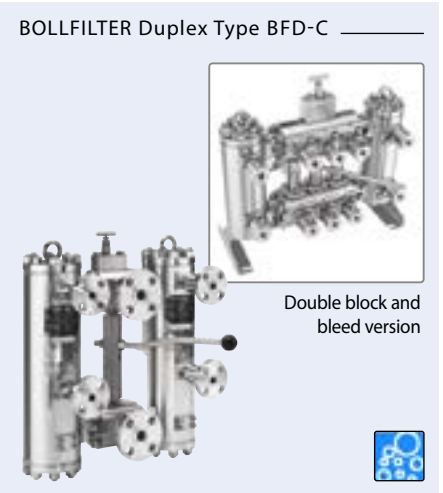

DN 20 – DN 200
 ball valve
 carbon steel, stainless steel;
 non-welded
 max. PN 500
 0,1 µm – 250 µm

Design and Operation

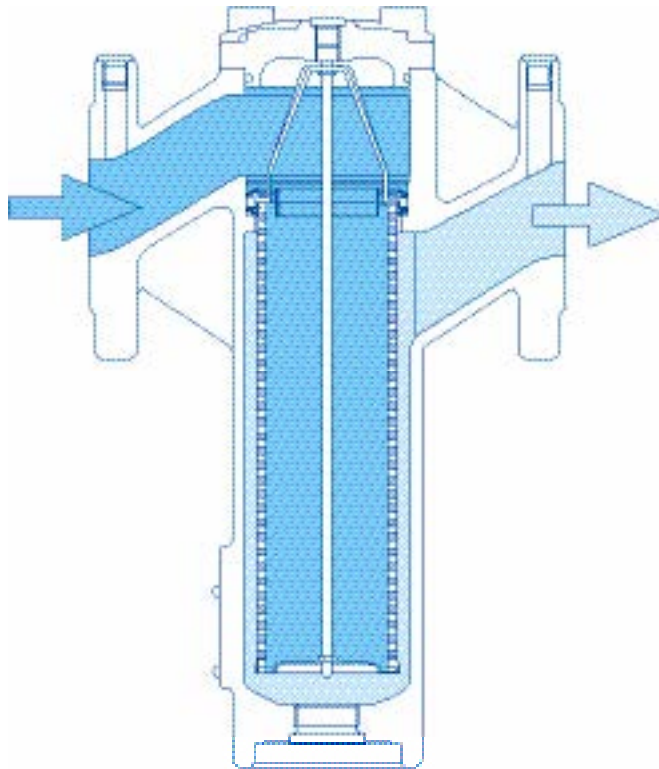

Filter types

BOLLFILTER Simplex Type 1.12.2



BOLLFILTER Simplex Type 1.03.2



Nominal diameters

Inline connections

Material variations
Filter housing

Pressure stages

Grades of filtration

DN 25 – DN 80

yes

nodular cast iron,
cast stainless steel (DN 25 und 50)

PN 32 / PN 40*

10 µm – 5000 µm

DN 65 – DN 300

yes

nodular cast iron,
nodular cast iron rubber lined

PN 10

10 µm – 5000 µm

* dependent on the filter size

Please contact us for detailed information
+49 2273 562-0 or info@bollfilter.com

Application

Simplex filters are the basic model of filter technology. They perform filtration tasks just as reliably as duplex filters or automatic filters. All filter elements with different filter materials can be installed. BOLLFILTER Simplex are used everywhere where process can be stopped at no great inconvenience or cost in order to clean or replace the filter elements.

Filtration of

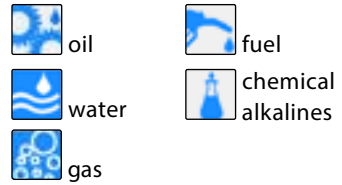

Installed in the pump pressure and suction line to protect the downstream plant components from contamination.

Advantages

- large filtration surfaces
- low pressure losses
- precisely defined grades of filtration
- long life time
- simple handling
- compact design

BOLLFILTER Simplex Type 1.65.1 / 1.53.1



DN 65 – DN 350

optional

carbon steel, stainless steel;
welded

PN 10 / PN 40*

10 µm – 5000 µm

BOLLFILTER Simplex Type 1.78.1 / 1.58.1



DN 65 – DN 350

no

carbon steel, stainless steel;
welded

PN 10 / PN 40*

3 µm – 250 µm

BOLLFILTER Simplex Type BFB-P/-C



DN 25 – DN 200

no

carbon steel, stainless steel;
non-welded

max. PN 500

0,1 µm – 250 µm

Design and Operation

The filter element is the core item of every filter. It essentially consists of a supporting body and a filter media. Various designs provide differing sized filtration surfaces. The required degree of filtration and cleaning can be achieved for every medium with the ideal combination of core components.

Type of element

Candle elements for automatic filters

In a candle element, several filter candles are assembled into a candle holder. This candle element is fitted in the filter housing and remains in the filter chamber during automatic cleaning by backflushing.

Candle elements

This filter element contains several plug-in or screw-in candles, connected in parallel, all with the same dimensions. This results in a large filtration surface within a small filter housing design. These filter elements are characterised by an especially high resistance to differential pressure.

Particle / coalescence element

The high-quality, extremely durable particle and coalescence elements are used for gas filtration and coalescence separation in chemical, petrochemical plants, the offshore sector and power stations.

Properties



Simplex filter types	–	1.03.2, 1.65.1/1.53.1	BFB-P/-C
Duplex filters types	–	2.05.5, BFD	BFD-P/-C
Automatic filter types	6.18/6.19, 6.18.2, 6.18.3C, 6.21/6.22, 6.46, 6.64, 6.72	–	–
Filtration grades from/to	dependent on type of filter and filter media	10 µm – 150 µm	> 0,1 µm
Filter media	stainless steel wire mesh, wedge wire profiles	stainless steel wire mesh	multi-layered microfibre glass
Magnetic insert	–	optional	optional
Flow direction	dependent on type of filter and filter element	►[]◄	[◄►]
Cleaning / replacement	automatic cleaning	manual cleaning	disposable

Filter cartridge

The filter cartridge is a disposable filter element for highest filtration requirements. The perforated plate supporting body guarantees optimum stability and optimum protection for the filter media.

Star-pleated element

The pleated filter media gives the filter element a large filtration surface on a small diameter. This allows long duty intervals and the use of fine filter meshes with low pressure losses.

Multimantle element

The multimantle element consists of several cylindrical filter mantles. These provide a large filtration surface with a small space requirement and allow the use of fine filter meshes.

Ring element

The ring element is constructed similarly to the basket element but it has an additional internal filter cylinder which increases the filtration area by approximately 30%.

Basket element

The basket element is suitable for coarse filtration. The contamination collects in the basket and can be removed easily for cleaning.



BOLLFILTER Simplex
Type 1.78.1/1.58.1,
BFB-P

BOLLFILTER Duplex
Type BFD, BFD-P,
2.04.5*

Flushing liquid treatment for type 6.64

3 µm – 50 µm

paper (1), polyester (2)
or fibre glass (3)

–

▶ [] ◀

disposable

*for type 2.04.5:
not applicable for
all housing sizes

BOLLFILTER Simplex
Type 1.12.2,
1.78.1/1.58.1,BFB-P

BOLLFILTER Duplex
Type 2.04.5, BFD,
BFD-P

–

10 µm – 250 µm*

stainless steel
wire mesh

optional

▶ [] ◀

manual cleaning

*for types
1.12.2, 2.04.5:
10 µm – 150 µm

BOLLFILTER Simplex
Type 1.03.2,
1.65.1/1.53.1

BOLLFILTER Duplex
Type 2.05.5

–

10 µm – 2000 µm

stainless steel
wire mesh

optional

▶ [] ◀

manual cleaning

BOLLFILTER Simplex
Type 1.03.2,
1.65.1/1.53.1

BOLLFILTER Duplex
Type 2.05.5

–

70 µm – 2000 µm

stainless steel
wire mesh

optional

[◀ ▶]

manual cleaning

BOLLFILTER Simplex
Type 1.12.2, 1.03.2,
1.65.1/1.53.1

BOLLFILTER Duplex
Type 2.04.5,
2.05.5, BFD

–

70 µm* – 5000 µm

stainless steel wire
mesh, perforated plate

optional



[◀ ▶]

manual cleaning

*for types
1.12.2, 2.04.5:
150 µm – 5000 µm

Mesh types and properties

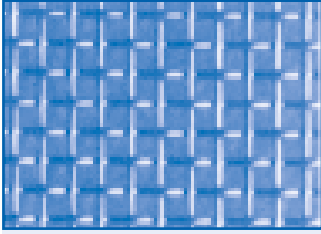
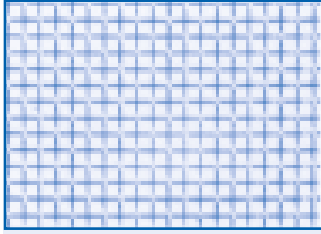
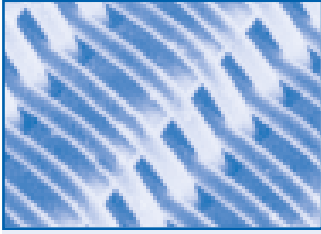
BOLLFILTERs are adapted individually to the widest possible range of applications. The use of the ideally suited type of mesh ensures the filter constantly fulfils its protective function and securely retains the defined solid particles. The maximum achievable grade of filtration depends on type of mesh, material, temperature and pressure resistance. Stainless steel wire meshes can be cleaned many times and can be used for long periods.

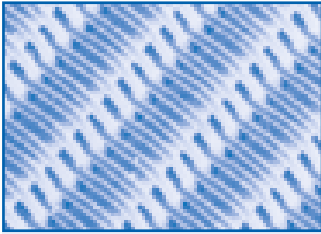
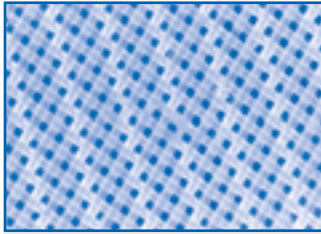
		
Type of weave	Linen weave	Linen weave
Version	02	03
Mesh no.	10	26
Picture scale	1:1	1:1,5
Mesh size (µm) (absolute)	2000	800
Passage area (%)	60	60
		
Type of weave	Special twist**	Five heddle-twilled-weave
Version	11	30
Mesh no.	128/18	5110
Picture scale	10:1	30:1
Mesh size (µm) (absolute)	80	80
Passage area (%)	44	20
		
Type of weave	Special twist**	Twill weave***
Version	19	20
Mesh no.	294/31	350/350
Picture scale	30:1	30:1
Mesh size (µm) (absolute)	34	34
Passage area (%)	44	24

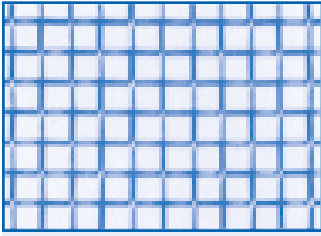

Linen weave

- 04
- 35
- 5:1
- 540
- 54

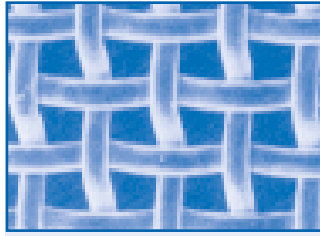

Linen weave

- 05
- 50
- 10:1
- 320
- 38

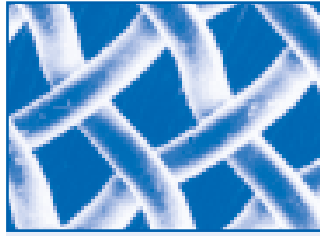

Linen weave

- 06
- 80
- 30:1
- 200
- 35

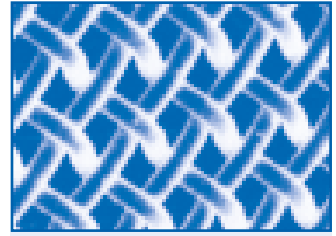

Linen weave

- 09
- 150
- 30:1
- 100
- 32

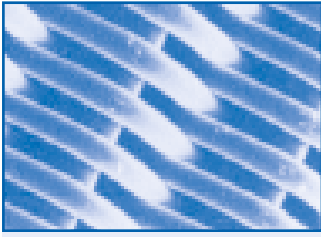

Special twist**

- 26
- 155/19
- 30:1
- 60
- 44

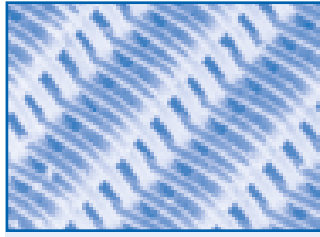

Special twist**

- 15
- 208/26
- 30:1
- 48
- 44

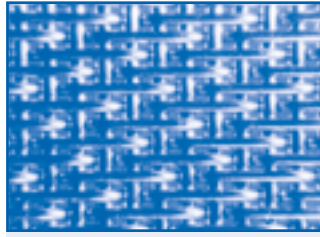

Five heddle-twilled-weave

- 32
- 5150
- 30:1
- 50
- 10

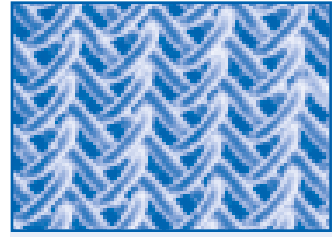

Twill weave

- 17
- 300/250
- 30:1
- 37
- 20

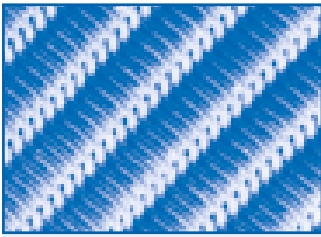

Special twist**

- 24
- 400/40
- 30:1
- 25
- 44

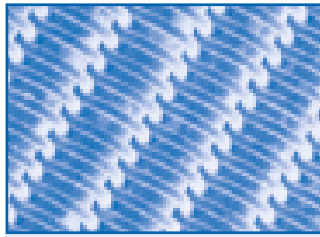

Special twist**

- 21
- 250/40
- 30:1
- 25
- 17,4

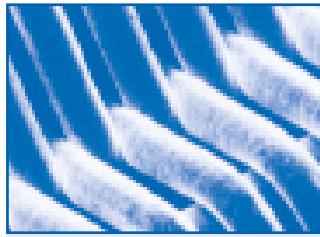

Special twist**

- 25
- 660/63
- 230:1
- 10

** wire mesh material:
Cr Ni Mo steel, material no.
1.4401/1.4301

*** wire mesh material:
polyester

